

# SQUILINDER® FIXED SUSPENDED MOUNT

A modern update to a timeless form, this award-winning, fresh-faced classic offers sleek geometry, field-changeable optics, and endless adjustability.

PROJECT NAME:	TYPE:
---------------	-------



## ORDERING INFORMATION - SQUILINDER



Quick Ship Product. All rough in components ship within 10 days up to quantities of 100.



JA8-2022 COMPLIANCE INDICATED BY SHADING

SQUILINDER	LENGTH	FIXTURE	RATING	SQUILINDER FINISH	BAFFLE FINISH	CRI / WATTAGE PACKAGE	CCT	OPTIC (UGR)	DRIVER	MEDIA	MOUNTING	
			<b>1</b>									
<b>Dropkit® STEM ASSEMBLY</b> SD2 3.13"	043 2" - 43" Mechanical Dropkit Stem	FB Fixed Body WW Fixed Body Wallwash	1 Dry/Damp	WH White AG Satin Silver* AB Architectural Bronze* BK Black CF Custom Finish*	WH White AG Satin Silver* AB Architectural Bronze* BK Black CF Custom Finish*	<b>STATIC WHITE</b> 80S11A 80+ CRI, 11 Watts Lm. Delivered - 1278 80S17A 80+ CRI, 17 Watts Lm. Delivered - 1960 80S23A 80+ CRI, 23 Watts Lm. Delivered - 2541 90S11A 90+ CRI, 11 Watts Lm. Delivered - 1098 90S17A 90+ CRI, 17 Watts Lm. Delivered - 1684 90S23A 90+ CRI, 23 Watts Lm. Delivered - 2183 97S11A 97+ CRI, 11 Watts Lm. Delivered - 964 97S17A 97+ CRI, 17 Watts Lm. Delivered - 1479 97S23A 97+ CRI, 23 Watts Lm. Delivered - 1917	24 2400K* 27 2700K 30 3000K 35 3500K 40 4000K	10 10° (>19) 15 15° (<16) 20 20° (<13) 25 25° (<16) 40 40° (<16) 60 60° (>19) WW Wallwash* *(Required for WW)	<b>INTEGRAL</b> CA3 120-277V 0-10V Analog CE3 120V Electronic Forward/Reverse <b>REMOTE (120V)</b> TR2 Philips, 2% Forward/Reverse L23 Lutron, Hi-Lume 1% 2-Wire <b>REMOTE (120-277V)</b> RA3 120-277V 0-10V Analog RE3 120V Electronic Forward / Reverse LH1 Lutron, Hi-Lume Ecosystem LP1 Lutron, Hi-Lume Premier Ecosystem AN4 Philips Xitanium 1% 0-10V, LOG LN2 Philips Xitanium 1% 0-10V, LIN EA2 eldoLED, SOLOdrive 0.1% 0-10V, LOG LA2 eldoLED, SOLOdrive 0.1% 0-10V, LIN ED1 eldoLED, SOLOdrive 0.1% DALI-2, LOG LD1 eldoLED, SOLOdrive 0.1% DALI-2, LIN AS1/ Athena Control ASR eldoLED, SOLOdrive 0.1% 120-277V* CS1/ Casambi Control CSR eldoLED, SOLOdrive 0.1% 120-277V* *(Includes Node, Extended lead time, consult factory. ASR/CSR includes shunt) <b>TUNABLE WHITE REMOTE (0.1%, 120-277V)</b> DD1 eldoLED, DUALdrive DALI-2, LOG DG1 eldoLED, DUALdrive 0-10V, LOG DN1 eldoLED, DUALdrive 0-10V, LIN AD1/ Athena Control, ADR eldoLED, DUALdrive* CD1/ Casambi Control, CDR eldoLED, DUALdrive* *(Includes Node, Extended lead time, consult factory for EM use, ADR/CDR includes shunt)	<b>STANDARD MEDIA</b> 40 Soft Focus Lens WW Wallwash Lens* *(Required for Wallwash fixtures) 00 No Lens* *(Standard for 10" optic. Not available for Warm Dim) <b>ALTERNATE MEDIA</b> 20 Honeycomb Louver* *(Not available for Warm Dim) 30 Clear Glass Lens* *(Not available for Warm Dim) 50 Frosted Glass Lens 60 Frosted Soft Focus Lens 70 Frosted Linear Spread Lens SL Soft Focus Lens w/ Linear Spread Film CL Clear Glass Lens w/ Linear Spread Film	<b>ROUGH-IN</b> JBMP 4" Sq. or 4/0 Junction Box Mounting Plate <b>FINISH OUT</b> SMK3 3/0 Surface Mount Kit* *(Not available for SD2) SMK4 4/0 Surface Mount Kit* *(Not available for SD2) CMJB 1/2" and 3/4" Conduit Ceiling Mount Junction Box* *(Quick Ship Product for WH and BK finishes only)	
	086 45" - 86" Mechanical Dropkit Stem											
	129 88" - 129" Mechanical Dropkit Stem											
	172 131" - 172" Mechanical Dropkit Stem											
	*All lengths are field cuttable											
<b>PENDANT</b> SP2 3.13"	XXXB Black Cable	FB Fixed Body	1 Dry/Damp	WH White AG Satin Silver* AB Architectural Bronze* BK Black CF Custom Finish*	WH White AG Satin Silver* AB Architectural Bronze* BK Black CF Custom Finish*	<b>WARM DIM</b> 90W18A 90+ CRI, 18 Watts Incandescent Profile Lm. Delivered - 1153 Halogen Profile Lm. Delivered - 1130 *SEE PAGE 4 FOR DETAILED WARM DIM PROFILE COMPARISON.	WL 2700K-1800K WD 3000K-1800K	20 20° (<10) 25 25° (<10) 40 40° (<13) 60 60° (<16) WW Wallwash* *(Required for WW)				
	XXXW White Cable											
	Specify cable length in whole inches (Max 180) ex. specify 006B for a 6 inch black cable* *(Cable is field cuttable)											
<div style="display: flex; justify-content: space-around; align-items: center;"> <div style="text-align: center;"> <p>(WH) White Powder Coat</p> </div> <div style="text-align: center;"> <p>(AG) Satin Silver Powder Coat</p> </div> <div style="text-align: center;"> <p>(AB) Architectural Bronze Powder Coat</p> </div> <div style="text-align: center;"> <p>(BK) Black Powder Coat</p> </div> </div> <p><b>PART NUMBER NOTES</b></p> <ul style="list-style-type: none"> <li>SD2 ships as e.g., SQ2-AD1-WHBK-90S23A2-30CA340</li> <li>Stem Assembly ships as SQ2-DK-(length)-(finish)</li> <li>SP2 ships as e.g., SP2-1801-WHBK-90S23A2-30RMT40W</li> <li>Mounting ships separate from fixture, part numbers listed on page 7.</li> </ul> <p>*ALL DELIVERED LUMEN OUTPUTS AND T24 COMPLIANCE REFLECT 3000K PAIRED WITH 20° OPTIC AND SOFT FOCUS LENS. REFERENCE PAGE 4 FOR ADDITIONAL T24 COMPLIANT CONFIGURATIONS.</p>												
						<b>TUNABLE WHITE</b> 90T17A 90+ CRI, 17 Watts Warm Profile Lm. Delivered - 991 Cool Profile Lm. Delivered - 982	TR 4000K-1800K TH 5000K-2700K	10 10° (>19) *(17W packages only) 15 15° (<16) 20 20° (<13) 25 25° (<16) 40 40° (<16) 60 60° (>19) WW Wallwash* *(Required for WW)				
*SEE PAGE 4 FOR UGR RATINGS												

# SQUILINDER FIXED SUSPENDED MOUNT

## ACCESSORIES

### ALTERNATE BAFFLE AND MEDIA

Includes baffle with sealed lens. Must specify baffle finish.

**RBA-SQ2-\*\*-HCL-2** Honeycomb Louver \*

\*(Not available for Warm Dim)

**RBA-SQ2-\*\*-CGL-2** Clear Glass Lens \*

\*(Not available for Warm Dim)

**RBA-SQ2-\*\*-SFL-2** Soft Focus Lens

**RBA-SQ2-\*\*-FGL-2** Frosted Glass Lens

**RBA-SQ2-\*\*-FSFL-2** Frosted Soft Focus Lens

**RBA-SQ2-\*\*-FLSL-2** Frosted Linear Spread Lens

**RBA-SQ2-\*\*-SFL-LSL-2** Soft Focus Lens W/ Linear Spread Film

**RBA-SQ2-\*\*-CGL-LSL-2** Clear Glass Lens W/ Linear Spread Film

\*\* Baffle finish: Specify **WH** for white, **BK** for black, **AG** for satin silver or

**AB** for architectural bronze.

### STATIC WHITE REPLACEMENT OPTICS

**RO-70-15-S** 15° optic

**RO-70-20-S** 20° optic

**RO-70-25-S** 25° optic

**RO-70-40-S** 40° optic

**RO-70-60-S** 60° optic

**RO-70-WW-S** Wallwash optic

### WARM DIM REPLACEMENT OPTICS

**RO-70-20-W** 20° optic

**RO-70-25-W** 25° optic

**RO-70-40-W** 40° optic

**RO-70-60-W** 60° optic

**RO-70-WW-W** Wallwash optic

### STATIC WHITE REPLACEMENT OPTICS

**RO-70-15-T** 15° optic

**RO-70-20-T** 20° optic

**RO-70-25-T** 25° optic

**RO-70-40-T** 40° optic

**RO-70-60-T** 60° optic

**RO-70-WW-T** Wallwash optic

### Dropkit STEM EXTENSION

**RPS-DK-EXT-\*\*-2** 2" - 43" Stem Extension

\*\* Stem finish: Specify **WH** for white, **BK** for black, **AG** for satin silver or **AB** for architectural bronze.

### REPLACEMENT SUCTION TOOL

Included with each order (1 per 10 fixtures).

**CY-SQ-TOOL-SUCTION** Baffle assembly removal tool

### EMERGENCY LIGHTING - REMOTE MOUNT ONLY

**EMB-S-25-120/277-LEDX** 25 watt max capacity, 120 or 277 VAC 60Hz

**EMB-S-100-120-LEDX** 100 watt max capacity, 120 VAC 60Hz, 0-10V dimmable

**EMB-S-100-277-LEDX** 100 watt max capacity, 277 VAC 60Hz, 0-10V dimmable

**EMB-S-250-120/277-LEDX** 250 watt max capacity, 120 or 277 VAC 60Hz

During disruption of main power, emergency battery inverter provides temporary 120V or 277V to fixture.

# SQUILINDER FIXED SUSPENDED MOUNT

## WALLWASH DESIGN GUIDE



**8FT MOUNTING HEIGHT  
36" SETBACK / 48" ON CENTER SPACING**

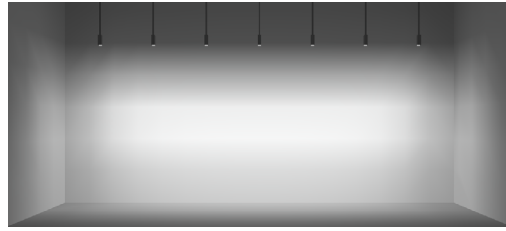

**10FT MOUNTING HEIGHT  
36" SETBACK / 48" ON CENTER SPACING**

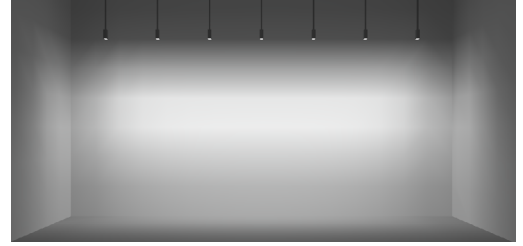

**12FT MOUNTING HEIGHT  
36" SETBACK / 48" ON CENTER SPACING**

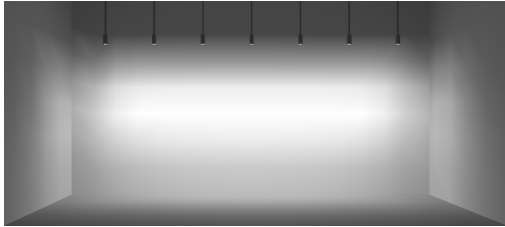

**30" SETBACK / 42" ON CENTER SPACING**

- AVERAGE FC: 17.19
- MAX / MIN: 5.71
- 10FT MOUNTING HEIGHT / 8-12FT IDEAL
- 7 FIXTURES / 25FT WALL SHOWN

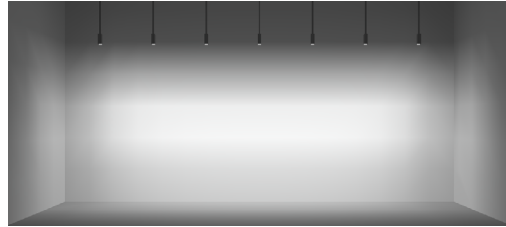

**RECOMMENDED**

**36" SETBACK / 48" ON CENTER SPACING**

- AVERAGE FC: 13.81
- MAX / MIN: 6.21
- 10FT MOUNTING HEIGHT / 8-12FT IDEAL
- 7 FIXTURES / 32FT WALL SHOWN

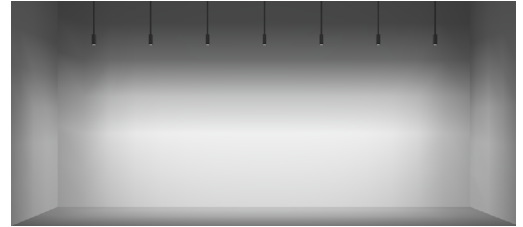

**42" SETBACK / 54" ON CENTER SPACING**

- AVERAGE FC: 11.14
- MAX / MIN: 7.32
- 10FT MOUNTING HEIGHT / 8-12FT IDEAL
- 7 FIXTURES / 32FT WALL SHOWN

### ADDITIONAL SETBACKS AND SPACINGS

ON CENTER SPACING	SETBACK		
	30"	36"	42"
30"	SHOWN ABOVE	AVERAGE FC: 13.93 MAX / MIN: 8.07	AVERAGE FC: 12.54 MAX / MIN: 8.54
36"	AVERAGE FC: 14.00 MAX / MIN: 6.22	SHOWN ABOVE	AVERAGE FC: 11.34 MAX / MIN: 7.78
42"	AVERAGE FC: 12.18 MAX / MIN: 7.73	AVERAGE FC: 11.04 MAX / MIN: 8.67	SHOWN ABOVE

**\*ALL DATA REFLECTS 90S17A WATTAGE PACKAGE**

# SQUILINDER FIXED SUSPENDED MOUNT

## STATIC WHITE PERFORMANCE - 3000K - SOFT FOCUS LENS

WATTAGE PACKAGE	WATTAGE	10° OPTIC NO LENS		15° OPTIC SOFT FOCUS LENS		20° OPTIC SOFT FOCUS LENS		25° OPTIC SOFT FOCUS LENS		40° OPTIC SOFT FOCUS LENS		60° OPTIC SOFT FOCUS LENS		WW OPTIC WALLWASH LENS	
		DLVD	LPW	DLVD	LPW	DLVD	LPW	DLVD	LPW	DLVD	LPW	DLVD	LPW	DLVD	LPW
80S11A	11	-	-	1289	117	1278	116	1282	117	1222	111	1154	105	913	83
80S17A	17	1513	89	1916	113	1960	115	1925	113	1846	109	1737	102	1395	82
80S23A	23	-	-	2440	106	2541	110	2515	109	2383	104	2240	97	1814	79
90S11A	11	-	-	1107	101	1098	100	1101	100	1050	95	991	90	784	71
90S17A	17	1304	77	1646	97	1684	99	1654	97	1586	93	1492	88	1198	70
90S23A	23	-	-	2096	91	2183	95	2161	94	2047	89	1924	84	1558	68
97S11A	11	-	-	972	88	964	88	967	88	922	84	870	79	688	63
97S17A	17	1125	66	1445	85	1479	87	1452	85	1392	82	1310	77	1052	62
97S23A	23	-	-	1840	80	1917	83	1897	82	1797	78	1689	73	1368	59
90W18AL (2700K-1800K)	18	-	-	-	-	1153	64	1133	63	1095	61	1037	58	858	48
90W18AD (3000K-1800K)	18	-	-	-	-	1130	63	1132	63	1093	61	1047	58	881	49
90T17ATR (4000K-1800K)	17	-	-	985	58	991	59	999	59	938	56	904	54	923	55
90T17ATH (5000K-2700K)	17	-	-	977	58	982	58	990	59	930	55	896	53	905	54

### MEDIA LIGHT LOSS MULTIPLIER

MEDIA	LIGHT LOSS FACTOR
No Lens	1.06
SFL	1.00
CGL	0.98
FGL	0.91
FSFL	0.87
FLSL	0.82
SFL W/ LIN. SPREAD	0.76
CGL W/ LIN. SPREAD	0.74
HCL	0.73

### OUTPUT MULTIPLIER

CCT	CCT SCALE
2400K	0.76
2700K	0.97
3000K	1.00
3500K	1.03
4000K	1.08

### TUNABLE WHITE MULTIPLIER

CCT	5000K-2700K	4000K-1800K
5000K	1.16	-
4000K	1.08	1.14
3500K	1.04	1.07
3000K	1.00	1.00
2700K	0.96	0.92
2400K	-	0.84
1800K	-	0.69

**TABLE 24** JA8-2022 INDICATED BY SHADING

### UNIFIED GLARE RATING

10° OPTIC NO LENS	15° OPTIC SOFT FOCUS LENS	20° OPTIC SOFT FOCUS LENS	25° OPTIC SOFT FOCUS LENS	40° OPTIC SOFT FOCUS LENS	60° OPTIC SOFT FOCUS LENS
>19	<16	<13	<16	<16	<19

## WARM DIM PERFORMANCE - SOFT FOCUS LENS - 20° OPTIC

### INCANDESCENT PROFILE

90W18AL 2700K - 1800K	Full on 100%	Dimmed to 80%	Dimmed to 70%	Dimmed to 50%	Dimmed to 20%	Dimmed to 10%	Dimmed to 2%
CCT (K)	2700	2650	2620	2520	2180	1950	1800
Light Output (Lm)	1153	922	807	576	231	115	23
Power (W)	18	14	13	9	4	2	.4
Efficacy (LPW)	64	64	64	64	64	64	64

### HALOGEN PROFILE

90W18AD 3000K - 1800K	Full on 100%	Dimmed to 80%	Dimmed to 70%	Dimmed to 50%	Dimmed to 20%	Dimmed to 10%	Dimmed to 2%
CCT (K)	3000	2950	2920	2775	2375	2000	1800
Light Output (Lm)	1130	904	791	565	226	113	23
Power (W)	18	14	13	9	4	2	.4
Efficacy (LPW)	62	62	62	62	62	62	62

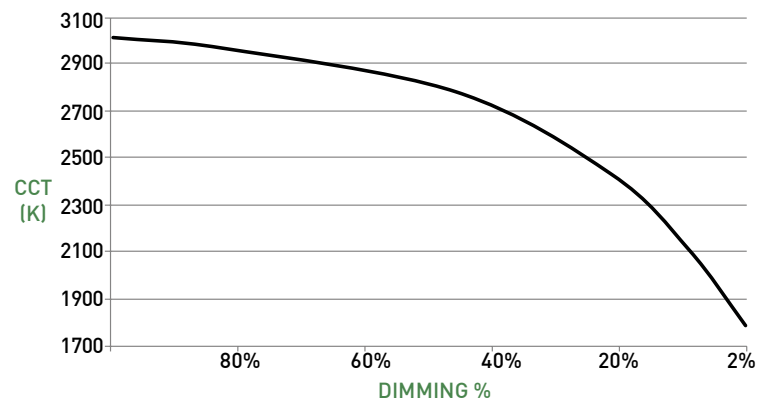
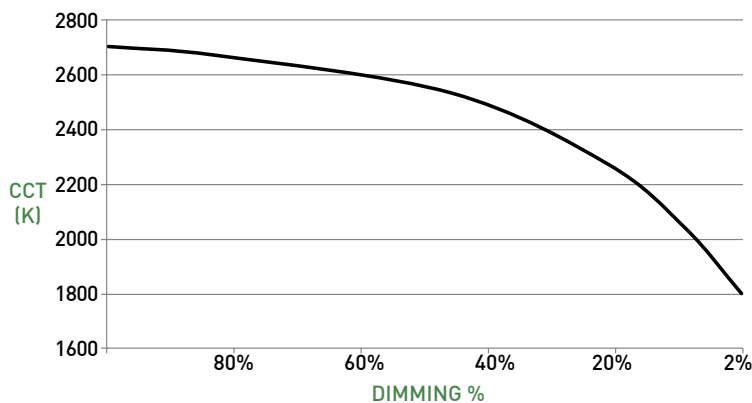

# SQUILINDER FIXED SUSPENDED MOUNT

## Dropkit STEM ASSEMBLY

- A LUMINAIRE**  
Machined body with integral heat sink and LED. Power supply may be integral or remote mount.
- B FIXED BODY OPTICS**  
Robust light engine with optimized optic pairing integrates Reflection, Refraction, and TIR offering 10°, 15°, 20°, 25°, 40° & 60° beams.
- WALLWASH OPTIC**  
Precision tuned optic provides uniform wallwashing effect.
- C FIXED BODY MEDIA**  
Soft focus lens or no lens standard; lenses sealed in place. Fixture can accept 1 media.
- WALLWASH MEDIA**  
Wallwash lens is sealed in place. Fixture can accept 1 media.
- D BAFFLE**  
Baffle minimizes aperture glare and conceals view into fixture. Suction tool provided for removal of baffle.
- E Dropkit**
  - Field cuttable rigid stem for suspending fixture at desired height. Provides stable base to allow preferred fixture tilt, while maintaining vertical stem position.
  - Ball joint allows up to 45° tilt for sloped ceilings and can be locked once stem is positioned vertically.
  - Four 43" sections available; 172" maximum standard length.
  - Length adjustment occurs in lower canopy.
  - Wiring for stem assembly provided by others.

## DIMENSIONS / DRAWINGS

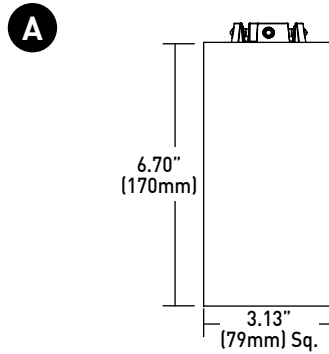

FIXED BODY

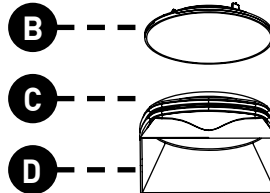

FIXED BODY WALLWASH

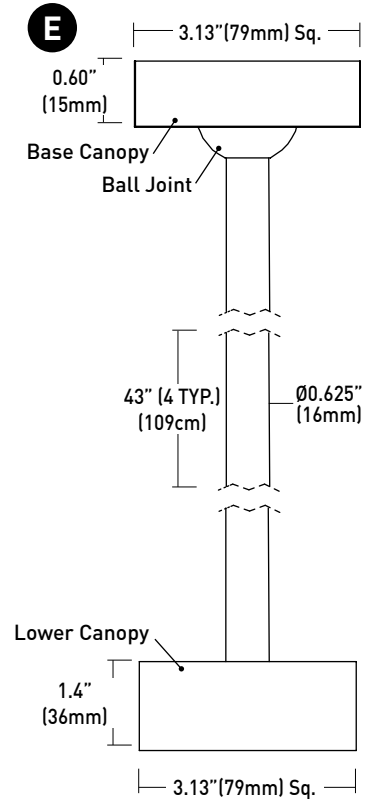
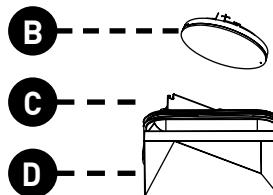
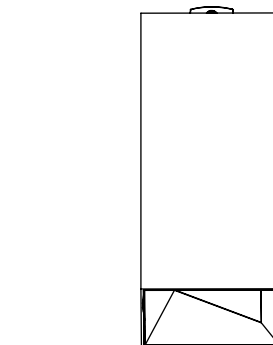

# SQUILINDER FIXED SUSPENDED MOUNT

## PENDANT

- F CANOPY**  
Machined 1.60" (41mm) canopy accommodates flat and slope ceiling conditions. Conceals hidden mounting hardware. Available with integral or remote driver.
- G CABLE**  
Black and white wiring harness available; up to 180.0" length; cable may be cut in field.
- H LUMINAIRE**  
Machined body with integral heat sink and LED.
- I STANDARD OPTICS**  
Robust light engine with optimized optic pairing integrates Reflection, Refraction, and TIR offering 10°, 15°, 20°, 25°, 40° & 60° beams.
- J MEDIA**  
Soft focus lens or no lens standard; lenses sealed in place. Fixture can accept 1 media.
- K BAFFLE**  
Baffle minimizes aperture glare and conceals view into fixture. Suction tool provided for removal of baffle.

## DIMENSIONS / DRAWINGS

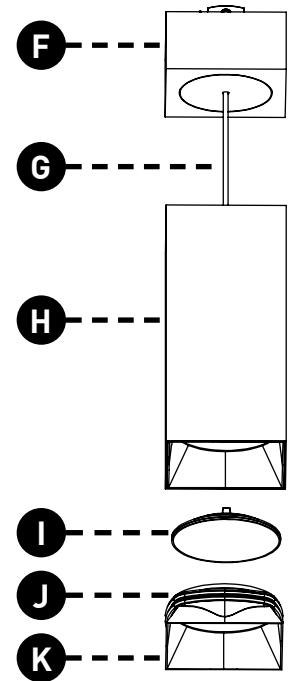
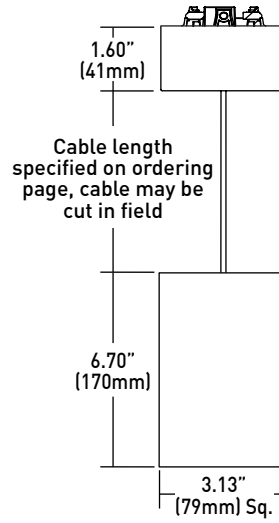

# SQUILINDER FIXED SUSPENDED MOUNT

## Dropkit STEM AND PENDANT MOUNTING

- L JBMP**  
Mounting plate (concealed) for standard 4" square or 4" 4/0 j-box . To be installed during rough-in prior to substrate. Fixture to mount flush with minimalist transition to ceiling.  
Part Number - SQ2-JBMP
- M SMK3**  
Surface mount kit includes mounting plate and 4" concealer plate that installs between fixture and standard 3" 3/0 j-box for existing applications where standard j-box cutout is to be concealed.  
Part Number - SQ2-SMK-3/0-(FINISH)
- N SMK4**  
Surface mount kit includes mounting plate and 5" concealer plate that installs between fixture and standard 4" 4/0 j-box for existing applications where standard j-box cutout is to be concealed.  
Part Number - SQ2-SMK-4/0-(FINISH)
- O CMJB**  
Ceiling mount junction box perfectly matches the squilinder profile for a continuous, integrated look where exposed ceiling mount junction box and conduit applications apply. For use with 1/2" and 3/4" EMT conduit only. Features three conduit entrances at 12, 3, and 6 o'clock plus one conduit knockout on top. Painted finishes only. Blank off plugs included.  
Part Number - SQ2-CMJB-(FINISH)

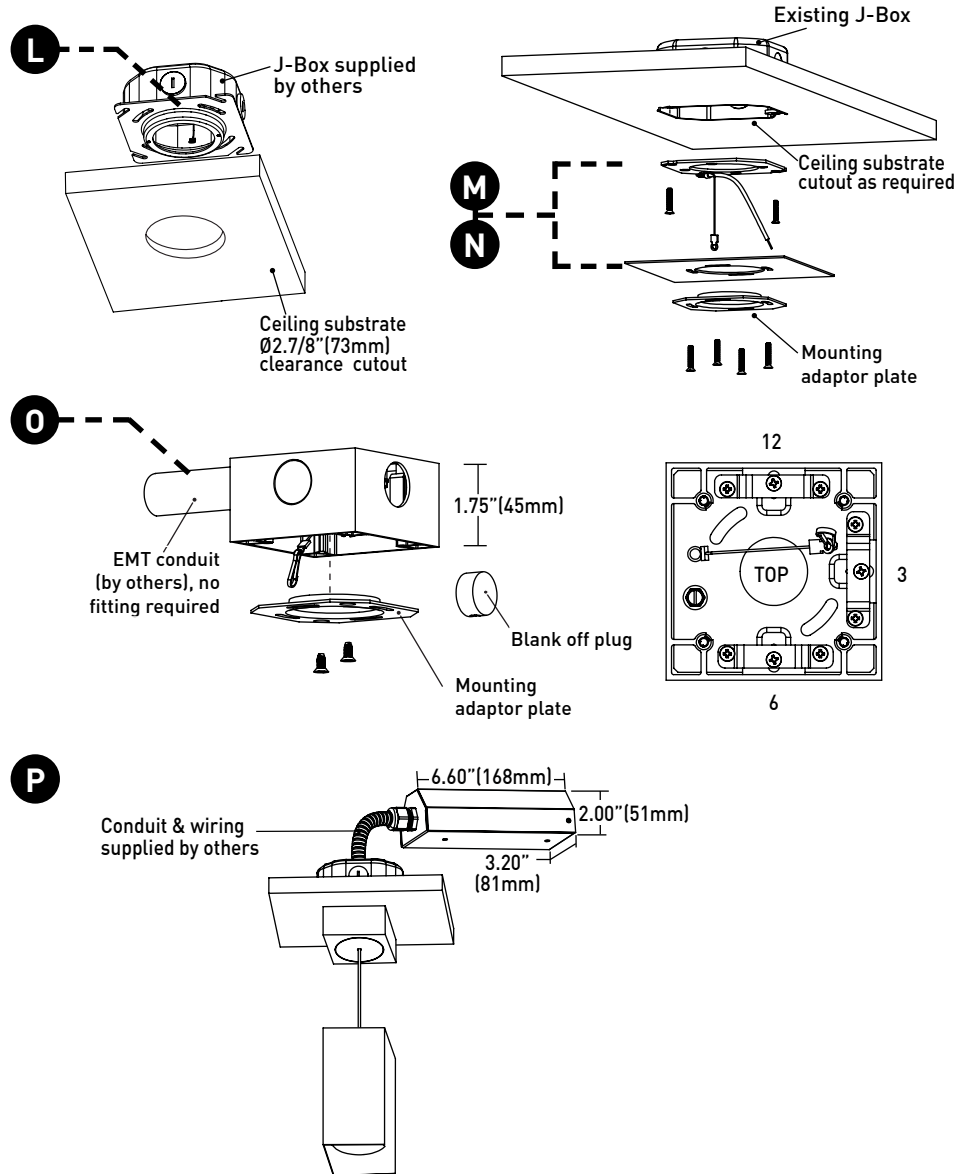

## MOUNTING NOTES

- JBMP not recommended for use with pancake style j-box.
- For applications involving slat ceilings or confined mounting, consult Comprehensive Install Guide for required clearances for proper air flow and servicing.

## REMOTE POWER SUPPLY

- P PS-RMT**  
Remote power supply provides additional driver options. Mounting device still required. See page 8 for maximum allowable secondary run lengths between PS-RMT and fixture
- Q ATHENA / CASAMBI CONTROL**  
Controls integrated into housing or remote driver assembly. All equipment is serviceable.  
Athena Model Numbers: A-WN-D01-RF-BL & DFC-OEM-DBI  
Casambi Model Number: BT-S1E1-5400
- R ATHENA / CASAMBI EM SHUNT**  
Included with drivers specified as ASR, ADR, CSR, or CDR. One required for each wireless EM fixture, requires class 2 control wiring between fixture and shunt. Features integrated test switch.  
Model Number: PS-RMT-SHUNT

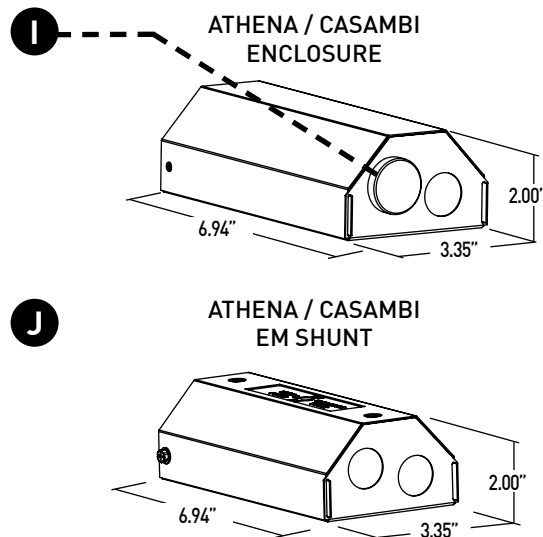

# SQUILINDER FIXED SUSPENDED MOUNT

## TECHNICAL

### CONSTRUCTION

**Squilinder:** Machined aluminum body; painted finishes are granulated powder coat.  
**Dropkit Stem Assembly:** Die-cast aluminum canopies and extruded aluminum stems; painted finishes are granulated powder coat.  
**CMJB:** Die-cast aluminum body; painted finishes are granulated powder coat.  
**Remote Power Supply:** 22 Gauge galvanized steel.

### STATIC WHITE LED

2-step MacAdam ellipse LED module available in 80+, 90+ and 97+ CRI configurations in color temperatures of 2700K, 3000K, 3500K and 4000K.  
 3-step MacAdam ellipse LED module available in 90+ configuration in color temperature of 2400K. Average rated lamp life of 50,000 hours. LED and driver assemblies are field-replaceable.

### WARM DIM LED

3-step MacAdam ellipse warm dim LED module available in 90+ CRI configuration. 3000K or 2700K at full brightness, warming to 1800K at full dim. Average rated lamp life of 50,000 hours. LED and driver assemblies are field-replaceable.

### TUNABLE WHITE LED

3-step MacAdam ellipse tunable white LED module available in 90+ CRI configuration. Features tuning range of 2700K to 5000K and 1800K to 4000K. Average rated lamp life of 50,000 hours. Driver assemblies are field-replaceable.

### POWER SUPPLY PERFORMANCE AND DIMMING INFORMATION

Power Supply	PHASE			0-10V								ECO		DALI			ATHENA	CASAMBI
	CE3/RE3	TR2	L23	CA3/RA3	AN4	EA2	LN2	EA2	LA2	DG1	DN1	LP1	LH1	ED1	LD1	DD1	AS1/AD1	CS1/CD1
Minimum °C	-20 °C	-20 °C	0 °C	-20 °C	-20 °C	-20 °C	-20 °C	-20 °C	-20 °C	-20 °C	-20 °C	0 °C	0 °C	-20 °C	-20 °C	-20 °C	0 °C	-20 °C
Maximum °C	40 °C	40 °C	40 °C	40 °C	40 °C	40 °C	40 °C	40 °C	40 °C	40 °C	40 °C	40 °C	40 °C	40 °C	40 °C	40 °C	40 °C	40 °C
Dimming %	2.0%	2.0%	1.0%	2.0%	1.0%	0.1%	1.0%	0.1%	0.1%	0.1%	0.1%	0.1%	1.0%	0.1%	0.1%	0.1%	0.1%	0.1%

Note: For TR2, L23, LH1, LP1, AN4, LN2, EA2 and LA2 drivers consult chart on page 9 to confirm appropriate dimming curve for compatibility with selected control.

### MAXIMUM ALLOWABLE REMOTE DRIVER WIRING DISTANCES

DRIVER	WIRE AWG				
	12	14	16	18	20
RA, RE	-	164'	105'	66'	40'
TR2, AN4, LN2	285'	180'	113'	71'	45'
L23, LH1, LP1	60'	40'	25'	15'	-
EA2, LA2, ED1, LD1, DG1, DD1, DN1 AS1, CS1, AD1, CD1	-	-	118'	72'	46'

### WALLWASH SPACING

Factory recommends 48" (1219mm) spacing on center with 36" (914mm) setback from wall plane.

### MOUNTING

Pendant is supplied with a mounting adaptor plate, which integrates with specified mounting component. Dropkit Stem integrates directly with specified mounting component. JBMP provide a minimalist transition from standard 4/0 or 4" square junction boxes and accommodating ceiling thicknesses of 0.44" (12mm) to 0.75" (19mm). Ceiling-mount junction box available for 1/2" (13mm) and 3/4" (19mm) conduit and feature concealed internal clamps for clean fitting-free conduit exit and entry.

### LISTING

cTUVus listed to UL1598 standard for Dry / Damp (IP14) locations. Title 24 JA8-2022 Listed. NEMA 410 Compliant

### FIXTURE WEIGHT

SD2 and Mounting - 5.8 lbs  
 SP2 and Mounting - 4.6 lbs  
 Remote Driver - 1.4 lbs

### LIMITED WARRANTY

Manufacturer's 1-year warranty guarantees product(s) listed to be free from defects in material and workmanship under normal use and service. 5-year warranty on LED and power supply to operate with 70% of the original flux and remain within a range of 3 duv. 10-year Lutron Advantage limited warranty available on Lutron equipped systems. Warranty period begins from the date of shipment by Seller. Consult [website](#) for full warranty terms and conditions.

### CHANGE LOG

- 01/12/2021: ADDED 2200K, 2700K-1800K WARM DIM AND 10 DEGREE OPTIC OFFERINGS.
- 03/17/2021: ADDED SMK MOUNTING OPTION FOR PENDANT
- 03/17/2021: ADDED CMJB MOUNTING OPTION FOR DROPKIT.
- 04/29/2021: ADDED FIXED BODY WALLWASH AND LP1 DRIVER OFFERINGS.
- 06/09/2022: ADDED HONEYCOMB LOUVER, SOFT FOCUS LENS W/ LINEAR SPREAD FILM, AND CLEAR GLASS LENS W/ LINEAR SPREAD FILM.
- 10/17/2022: REMOVED 90W13A 3200K-1800K WARM DIM AND ADDED 90W18AD 3000K-1800K WARM DIM.
- 03/03/2023: ADDED SMK3 AND SMK4 MOUNTING OPTIONS FOR SP2.
- 08/08/2023: ADDED NEW LED AND OPTIC OFFERINGS. REMOVED 2200K OFFERING.
- 11/11/2024: ADDED ATHENA/CASAMBI OFFERINGS, ADDED 2400K OFFERING.
- 2/07/2024: ADDED TUNABLE WHITE OFFERING.



# SQUILINDER FIXED SUSPENDED MOUNT

## DIMMING COMPATIBILITY

### PHILIPS DRIVER COMPATIBILITY

Power supply <b>TR2</b> Manufacturer	Family/Model #
Lutron Electronics	DV-600P
Lutron Electronics	DVELV-303P
Lutron Electronics	NTELV-600
Lutron Electronics	MAELV-600
Lutron Electronics	SELV-300P
Lutron Electronics	DVLV-600P
Lutron Electronics	NFTU-5A
Lutron Electronics	CTCL-153P
Lutron Electronics	GL-600H
Lutron Electronics	S-600P
Lutron Electronics	PHPM
Power supply <b>AN4 / LN2</b> Manufacturer	Family/Model #
Lutron Electronics	DVTV plus PP-DV
Lutron Electronics	DVSCTV plus PP-DV
Lutron Electronics	DVSTV
Lutron Electronics	DVSCSTV
Lutron Electronics	QSGRJ-XP plus GRX-TVI
Lutron Electronics	QSGRJ-XE plus GRX-TVI
Lutron Electronics	QSGR-XE plus GRX-TVI
Lutron Electronics	NFTV plus PP-DV
Lutron Electronics	NTSTV
Lutron Electronics	RMJ-5T
Lutron Electronics	RMJS-8T
Lutron Electronics	FCJS-010
Leviton	IllumaTch IP7 series
Philips	Sunrise - SR1200ZTUNV

### LUTRON DRIVER COMPATIBILITY

Power supply <b>L23</b> Lutron Product Family	Part No.
Maestro WirelessR 600 W dimmer	MRF2-6ND-120-
Maestro WirelessR 1000 W dimmer	MRF2-10ND-120-
Caséta® Wireless Pro 1000 W dimmer	PD-10NXD-
GRAFIK T™ CL® dimmer	GT-250M-GTJ-250M-
HomeWorks® QS adaptive dimmer	HQRD-6NA-
HomeWorks® QS 600 W dimmer	HQRD-6ND-
HomeWorks® QS 1000 W dimmer	HQRD-10ND-
RadioRA® 2 adaptive dimmer	RRD-6NA-
RadioRA® 2 1000 W dimmer	RRD-10ND
myRoom™ DIN power module	MQSE-4A1-D
HomeWorks® QS DIN power module	LQSE-4A1-D
HomeWorks® QS wallbox power module	HQRJ-WPM-6D-120
HomeWorks® wallbox power module	HWI-WPM-6D-120
GRAFIK Eye® QS control unit	QSGR-, QSGRJ-
GRAFIK Eye® 3000 control unit	GRX-3100-GRX-3500-
RPM-4U module (LCP, HomeWorks® QS, GRAFIK Systems™, Quantum®)	HW-RPM-4U-120 LP-RPM-4U-120
RPM-4A module (LCP, HomeWorks® QS, GRAFIK Systems™, Quantum®)	HW-RPM-4A-120, LP-RPM-4A-120
GP dimming panels	Various
Ariadni CL 250W dimmer	AYCL-253P-
Diva CL 250W dimmer	DVCL-253P-DCSCCL-253P-
Nova T CL 250W dimmer	NTCL-250-
Power supply <b>LH1 / LP1</b> Lutron Product Family	Part No.
PowPak Dimming Modules	RMJ-ECO32-DV-B
PowPak Dimming Modules	FCJ/FCJS-ECO
Energi Savr Nodes	QSN-1ECO-S
GRAFIK Eye QS control unit	QSN-2ECO-S
Homeworks QS control unit	QSGRJ- _E (wireless) QSGR- _E
Quantum Hub	QP2-__ 2C
Quantum Hub	QP2-__ 4C
Quantum Hub	QP2-__ 6C
Quantum Hub	QP2-__ 8C
Homeworks QS power module	LQSE-2ECO-D
myRoom Plus power module	

### eldoLED DRIVER COMPATIBILITY

Power supply <b>EA2 / LA2</b> Dimmer / Switch Control Manufacturer	Family/Model #
Busch-Jaeger	2112U-101
Jung	240-10
Leviton Lighting Controls	IP710-DLX
Lightolier Controls	ZP600FAM120
Lutron Electronics	Nova T® - NTFTV
Lutron Electronics	Divva® - DVTV
Lutron Electronics	Nova® - NFTV
Merten	5729
Pass & Seymour	CD4FB-W
The Watt Stopper	DCLV1
Sensor Switch	nI0 EZ
Synergy	ISD BC
Power supply <b>EA2 / LA2</b> Dimmer / Switch Control Manufacturer	Family/Model #
Dimmer / Switch Control Manufacturer	GrafixEye® GRX-TVI w GRX3503
Lutron Electronics	Energy Savr Node™ - QSN-4T16-S
Lutron Electronics	TVM2 Module
Crestron®	GLX-DIMFLV8
Crestron®	GLXP-DIMFLV8
Crestron®	GLPAC-DIMFLV4-*
Crestron®	GLPAC-DIMFLV8-*
Crestron®	GLPP-DIMFLVEX-PM
Crestron®	GLPP-1DIMFLV2EX-PM
Crestron®	GLPP-1DIMFLV3EX-PM
Crestron®	DIN-A08
Crestron®	DIN-4DIMFLV4
Crestron®	CLS-EXP-DIMFLV
Crestron®	CLCI-1DIMFLV2EX
ABB	SD/S 2.16.1

## ANALOG DRIVERS AND DIMMERS

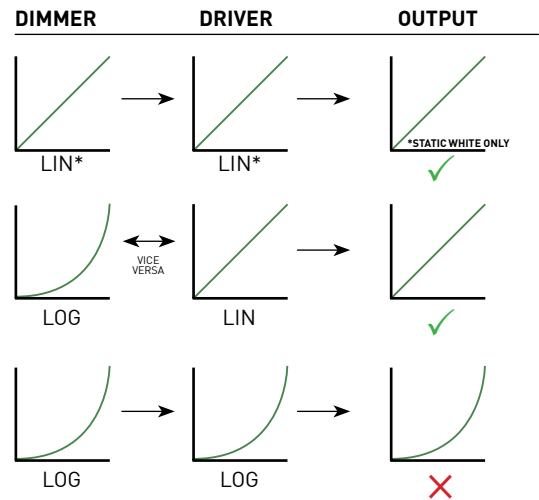

LIN = LINEAR  
 LOG = LOGARITHMIC  
 \*LIN-TO-LIN NOT COMPATIBLE FOR WARM-DIM

