

FRAXION® 4 SLIM DEEP REGRESS FIXED

Fraxion4 Slim incorporates an LED, optic, and housing into a single complete unit featuring a removable baffle and trim. Conversely, Fraxion4 offers a separate housing and trim assembly.

PROJECT NAME:	TYPE:
---------------	-------

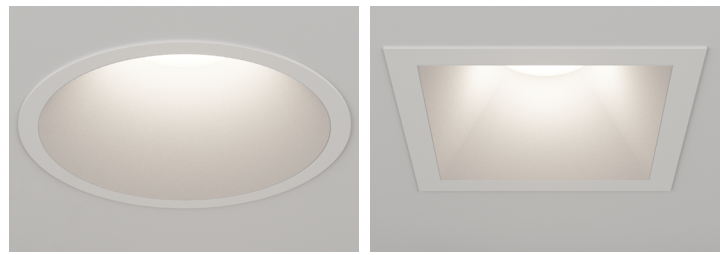

ORDERING INFORMATION - DOWNLIGHT / HOUSING



J A8-2022 INDICATED BY SHADING

SHAPE	TRIM	RATING	FLANGE FINISH	BAFFLE FINISH	CRI / WATTAGE PACKAGE	CCT	OPTIC (UGR)	INSTALL TYPE	CEILING THICKNESS	DRIVER	MEDIA
F4R Round	FFD Standard Flange	1 Dry/Damp 2 Wet* * (Suction cup provided for aim and focus)	WH White	WH White	STATIC WHITE 2.42" TALL HOUSING 80S11A 80+ CRI, 11W, Lumens Divd. - 1209 80S15A 80+ CRI, 15W, Lumens Divd. - 1610 80S21A 80+ CRI, 21W, Lumens Divd. - 2175 80S30B 80+ CRI, 30W, Lumens Divd. - 2950* * (Not available for IC housing applications) 80S36B 80+ CRI, 36W, Lumens Divd. - 3459* * (Not available for IC housing applications) 90S11A 90+ CRI, 11W, Lumens Divd. - 1038 90S15A 90+ CRI, 15W, Lumens Divd. - 1383 90S21A 90+ CRI, 21W, Lumens Divd. - 1869 90S30B 80+ CRI, 30W, Lumens Divd. - 2534* * (Not available for IC housing applications) 90S36B 90+ CRI, 36W, Lumens Divd. - 2972* * (Not available for IC housing applications) 97S11A 97+ CRI, 11W, Lumens Divd. - 912 97S15A 97+ CRI, 15W, Lumens Divd. - 1214 97S21A 97+ CRI, 21W, Lumens Divd. - 1641 97S30B 90+ CRI, 30W, Lumens Divd. - 2225* * (Not available for IC housing applications) 97S36B 90+ CRI, 36W, Lumens Divd. - 2609* * (Not available for IC housing applications)	24 2400K* * (90+ CRI only. Not available for 30W or 36W packages) 27 2700K 30 3000K 35 3500K* * (Not available with 97S30B or 97S36B) 40 4000K	10 10° (<13) * (15W packages only) 15 15° (<16) 20 20° (<13) 25 25° (<13) 40 40° (<13) 60 60° (<13) 85 85° (<19) * (Requires -14 WDL effects device)	INTEGRAL DRIVER X IC Y NIC C IC, Airtight* * (CCEA, Airtight & Title 24 compliant housing)	1 0.50" - 1.00" T TG 0.50" - 1.00"* * (Includes adjustable housing height bracket)	DOMESTIC (120V) TR2 Philips, 2% Leading/Trailing/Trac* * (Not available for 30W or 36W packages) L23 Lutron, Hi-Lume 1% 2-Wire UNIVERSAL (120-277V) LH1 Lutron, Hi-Lume 1% Ecosystem LP1 Lutron, Hi-Lume Premier 0.1% Ecosystem* * (Not available for 30W or 36W packages) AN4 Philips Titanium 1% 0-10V, LOG LN2 Philips Titanium 1% 0-10V, LIN EA2 eidoLED, SOLOdrive 0.1% 0-10V, LOG LA2 eidoLED, SOLOdrive 0.1% 0-10V, LIN ED1 eidoLED, SOLOdrive 0.1% DALI-2, LOG AS1 / Athena Control ASR eidoLED, SOLOdrive 0.1%* * (Includes Athena Node. Extended lead time, consult factory. ASR includes shunt) CS1 / Casambi Control CSR eidoLED, SOLOdrive 0.1%* * (Includes Casambi Node. Extended lead time, consult factory. CSR includes shunt)	STANDARD MEDIA 04 Soft Focus Lens NL No Lens* * (Standard with 10° optic. Not available for Wet Location, or Airtight Housings)
	F4S Square		FFD Standard Flange MFD Microflange TFD Trimless	BB Burnt Bronze BK Black PR Primer 00 Trimless* * (Required for trimless) CF Custom Finish* * (Consult Factory)							
					TUNABLE WHITE 2.42" TALL HOUSING 90T15B 90+ CRI, 15W Cool Profile: 5000K - 2700K Lumens Divd. - 1198 Warm Profile: 4000K - 1800K Lumens Divd. - 1209 90T22B 90+ CRI, 22W Cool Profile: 5000K - 2700K Lumens Divd. - 1680 Warm Profile: 4000K - 1800K Lumens Divd. - 1696 LUMEN DELIVERED OUTPUTS AND T24 COMPLIANCE REFLECT 3000K PAIRED WITH 60° OPTIC AND SOFT FOCUS LENS	TH 5000K - 2700K TR 4000K - 1800K	15 15° (<13) 20 20° (<10) 25 25° (<10) 40 40° (<10) 60 60° (<10) 85 85° (>19) * (Requires -14 WDL effects device)	SEE PAGE 3 FOR UGR RATINGS	TUNABLE WHITE POWER SUPPLIES (120-277V) DD1 eidoLED, DUALdrive 0.1% DALI-2, LOG DG1 eidoLED, DUALdrive 0.1% 0-10V, LOG DL1 eidoLED, DUALdrive 0.1% 0-10V, LIN AD1 / Athena Control ADR eidoLED, DUALdrive 0.1%* * (Includes Athena Node. Extended lead time, consult factory. ADR includes shunt) CD1 / Casambi Control CDR eidoLED, DUALdrive 0.1%* * (Includes Casambi Node. Extended lead time, consult factory. CDR includes shunt)		



PART NUMBER NOTES

- Housing and trim ship as e.g., F4RMFD1-WHWH-90S15A2-3X1-AN4



Declare.

FRAZION4 SLIM DEEP REGRESS FIXED

ACCESSORIES

ALTERNATE MEDIA

Dry/Damp location only.

Wet location requires alternate baffle.

- HCL-F4R-2** Honeycomb Louver w/ Diffusion Film*
*(Not available for Warm Dim, or Airtight housings)
- CGL-F4R-2** Clear Glass Lens*
*(Not available for Warm Dim)
- FGL-F4R-2** Frosted Glass Lens
- SFL-F4R-2** Soft Focus Lens
- FSFL-F4R-2** Frosted Soft Focus Lens
- WDL-F4R-2** Wide Distribution Lens*
*(Required and only available for 85° beam spread)
- FLSL-F4R-2** Frosted Linear Spread Lens

REPLACEMENT BAFFLE ASSEMBLY (INCLUDES MEDIA)

ASSEMBLY	SHAPE	TRIM	RATING	FLANGE FINISH	MEDIA
RBA				1	
REPLACEMENT BAFFLE ASSEMBLY	F4R Round	FFD Standard Flange MFD Microflange TFD Trimless	1 Dry / Damp 2 Wet* *(Requires provided suction cup to service or aim & focus)	WH White BK Black PR Primer AU Cashmere Gold AG Satin Silver BB Burnt Bronze CF Custom Finish* *(Consult Factory)	<p style="text-align: center;">Leave blank for standard Soft Focus Lens</p> <p>HCL Honeycomb Louver w/ Diffusion Film* *(Not available for Wet Location, Warm Dim, or Airtight Housings)</p> <p>CGL Clear Glass Lens* *(Not available for Warm Dim)</p> <p>FGL Frosted Glass Lens</p> <p>FSFL Frosted Soft Focus Lens</p> <p>WDL Wide Distribution Lens* *(Required and only available for 85° beam spread)</p> <p>FLSL Frosted Linear Spread Lens</p>
	F4S Square	FFD Standard Flange Transitional Baffle MFD Microflange Transitional Baffle TFD Trimless Transitional Baffle			

REPLACEMENT OPTICS

Interchangeable optics accessible through fixture aperture.

STATIC WHITE

- RO-70-15-S** 15° optic
- RO-70-20-S** 20° optic
- RO-70-25-S** 25° optic
- RO-70-40-S** 40° optic
- RO-70-60-S** 60° optic

WARM DIM

- RO-70-20-W** 20° optic
- RO-70-25-W** 25° optic
- RO-70-40-W** 40° optic
- RO-70-60-W** 60° optic

TUNABLE WHITE

- RO-70-15-T** 15° optic
- RO-70-20-T** 20° optic
- RO-70-25-T** 25° optic
- RO-70-40-T** 40° optic
- RO-70-60-T** 60° optic

REPLACEMENT SUCTION TOOL

One included with every six fixtures designated Wet location.

- F4-TOOL-SUCTION** Allows for removal of baffle with Wet location

T-GRID ACCESSORY KIT

Supplied with ceiling thickness "T" and recommended for installations in T-Grid up to 1.5" tall. Available for ceiling thicknesses from 0.5" - 1.0".

- DHA-TG-KIT**

FURRING CHANNEL ACCESSORY KIT

Recommended for installations in furring channel. Available for ceiling thicknesses from 0.5" - 1.0".

- DHA-FC-KIT**

HANGER BAR EXTENDER KIT

Extends hanger bars from 24.0" to 46.0" maximum.

- FRX-HBE-46** Extender, Hanger Bar

EMERGENCY LIGHTING - REMOTE MOUNT ONLY

During disruption of main power, emergency battery inverter provides temporary 120V or 277V to fixture.

- EMB-S-25-120/277-LEDX** 25 watt max capacity, 120 or 277 VAC 60Hz, Non-Dimmable
- EMB-S-100-120-LEDX** 100 watt max capacity, 120 VAC 60Hz, 0-10V Dimmable
- EMB-S-100-277-LEDX** 100 watt max capacity, 277 VAC 60Hz, 0-10V Dimmable
- EMB-S-250-120/277-LEDX** 250 watt max capacity, 120 or 277 VAC 60Hz, 0-10V Dimmable

***SHUNT REQUIRED FOR USE WITH ATHENA AND CASAMBI CONTROLS, CONSULT FACTORY FOR DETAILS.**

FRAXION4 SLIM DEEP REGRESS FIXED

PERFORMANCE - 3000K

24 JA8-2022 INDICATED BY SHADING

PACKAGE	WATTS	10° OPTIC NO LENS		15° OPTIC SOFT FOCUS LENS		20° OPTIC SOFT FOCUS LENS		25° OPTIC SOFT FOCUS LENS		40° OPTIC SOFT FOCUS LENS		60° OPTIC SOFT FOCUS LENS		85° OPTIC WIDE DISTRIBUTION	
		DLVD.	LPW	DLVD.	LPW	DLVD.	LPW	DLVD.	LPW	DLVD.	LPW	DLVD.	LPW	DLVD.	LPW
80S11A	11	-	-	999	91	1129	103	1189	108	1037	94	1209	110	992	90
80S15A	15	1174	107	1346	90	1519	101	1478	99	1342	89	1610	107	1336	89
80S21A	21	-	-	1864	89	2036	97	1997	95	1814	86	2175	104	1818	87
80S30B	30	-	-	2449	82	2792	93	2690	90	2428	81	2950	98	2495	83
80S36B	36	-	-	2888	80	3289	91	3179	88	2863	80	3459	96	2940	82
90S11A	11	-	-	858	78	970	88	1021	93	891	81	1038	94	852	77
90S15A	15	1012	92	1156	77	1305	87	1270	85	1153	77	1383	92	1148	77
90S21A	21	-	-	1601	76	1749	83	1716	82	1558	74	1869	89	1562	74
90S30B	30	-	-	2104	70	2399	80	2311	77	2086	70	2534	84	2143	71
90S36B	36	-	-	2481	69	2826	78	2731	76	2459	68	2972	83	2526	70
97S11A	11	-	-	754	69	851	77	897	82	72	71	912	83	748	68
97S15A	15	873	79	1015	68	1146	76	1115	74	1012	67	1214	81	1008	67
97S21A	21	-	-	146	67	1536	73	1507	72	1368	65	1641	78	1371	65
97S30B	30	-	-	1847	62	2106	70	2029	68	1832	61	2225	74	1882	63
97S36B	36	-	-	2178	61	2481	69	2398	67	2159	60	2609	72	2218	62
90W15A (WL 27K-18K)	15	-	-	-	-	994	66	937	62	833	56	1022	68	878	59
90W15A (WD 30K-18K)	15	-	-	-	-	995	66	938	63	838	56	1031	69	885	59
90T15B (40K-18K)	15	-	-	1082	72	1140	76	1097	73	991	66	1209	81	999	67
90T15B (50K-27K)	15	-	-	1072	71	1130	75	1087	72	982	65	1198	80	990	66
90T22B (40K-18K)	22	-	-	1497	68	157+	72	1504	68	1374	62	1696	77	1394	63
90T22B (50K-27K)	22	-	-	1483	67	1561	71	1491	68	1362	62	1680	76	1381	63

OUTPUT MULTIPLIER

CCT	CCT SCALE
2400K	0.85
2700K	0.97
3000K	1.00
3500K	1.03
4000K	1.08

MEDIA LIGHT LOSS FACTOR

MEDIA	LIGHT LOSS FACTOR
NO LENS	1.06
CGL	1.00
SFL	1.00
FGL	0.89
FSFL	0.81
FLSL	0.82
HCL	0.73

TUNABLE WHITE MULTIPLIER

CCT	5000K-2700K	4000K-1800K
5000K	1.16	-
4000K	1.08	1.14
3500K	1.04	1.07
3000K	1.00	1.00
2700K	0.96	0.92
2400K	-	0.84
1800K	-	0.69

UNIFIED GLARE RATING

10° OPTIC NO LENS	15° OPTIC SOFT FOCUS LENS	20° OPTIC SOFT FOCUS LENS	25° OPTIC SOFT FOCUS LENS	40° OPTIC SOFT FOCUS LENS	60° OPTIC SOFT FOCUS LENS	85° OPTIC WIDE DISTRIBUTION
<13	<16	<13	<13	<13	<13	>19

FRAXION4 SLIM DEEP REGRESS FIXED

WARM DIM PERFORMANCE - 60° OPTIC - SOFT FOCUS LENS

WARM DIM TO MIRROR INCANDESCENT DIMMING PROFILE

WL 2700K - 1800K	Full on 100%	Dimmed to 80%	Dimmed to 70%	Dimmed to 50%	Dimmed to 20%	Dimmed to 10%	Dimmed to 2%
CCT (K)	2700	2650	2620	2520	2180	1950	1800
Light Output (Lm)	1022	817	715	511	204	102	20
Power (W)	15	12	10.5	7.5	3	1.5	.3
Efficacy (LPW)	68	68	68	68	68	68	68

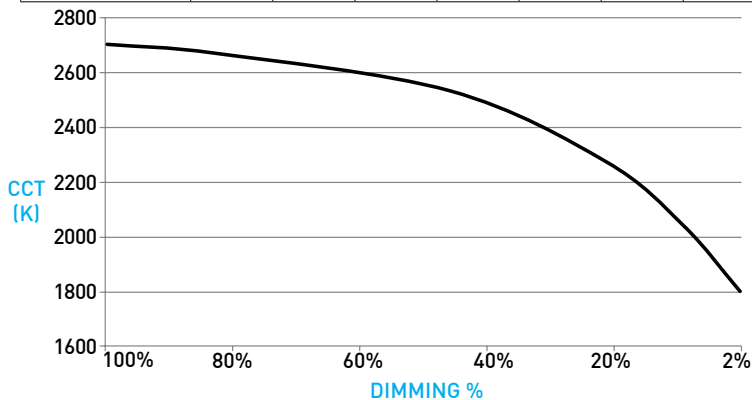

HALOGEN WARM DIM PROFILE

WD 3000K - 1800K	Full on 100%	Dimmed to 80%	Dimmed to 70%	Dimmed to 50%	Dimmed to 20%	Dimmed to 10%	Dimmed to 2%
CCT (K)	3000	2950	2920	2775	2375	2000	1800
Light Output (Lm)	1031	824	721	515	206	103	20
Power (W)	15	12	10.5	7.5	3	1.5	.3
Efficacy (LPW)	69	69	69	69	69	69	69

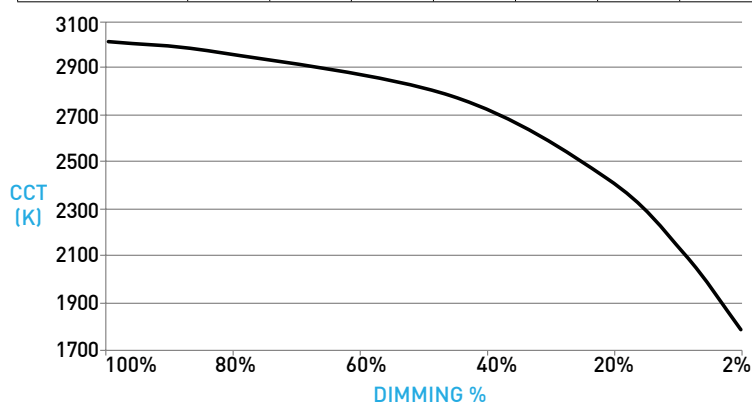

FRAXION4 SLIM DEEP REGRESS FIXED

DOWNLIGHT / HOUSING

- A LED**
Integral LED module design enables field service / replacement through housing aperture.
- B OPTIC**
Robust light engine with optimized optic pairing integrates Reflection, Refraction and TIR offering 10°, 15°, 20°, 25°, 40° & 60° beams.
- C1 STANDARD FLANGE PROFILE**
Installed after ceiling is complete. Requires 4.625" diameter cutout. Provides 0.86" total contractor (goof) allowance with 0.50" flange. Thickness measures 0.06". Wet location features integral silicone gasket.
- C2 MICROFLANGE PROFILE**
Installed after ceiling is complete. Requires 4.625" diameter cutout. Provides 0.42" total contractor (goof) allowance with 0.28" flange. Thickness measures 0.06". Wet location features integral silicone gasket.
- C3 TRIMLESS PROFILE**
Installs totally flush with the ceiling with no visible trim. Appliqué includes screws for mounting and has 0.06" plaster stop. Not recommended for stucco applications.
- D MEDIA**
Soft focus lens included and sealed in Wet location option. Fixture is limited to 1 media. Suction tool provided for removal of wet location baffles.
- E1 ROUND BAFFLE**
Die-cast deep removable baffle features 60° glare cutoff. Minimizes aperture glare and conceals view into housing; includes silicone gasket.
- E2 TRANSITIONAL BAFFLE**
Die-cast deep baffle transitions from square aperture at ceiling plane to round aperture at light source and features 60° glare cutoff. Minimizes aperture glare and conceals view into housing; includes silicone gasket.

DIMENSIONS / DRAWINGS

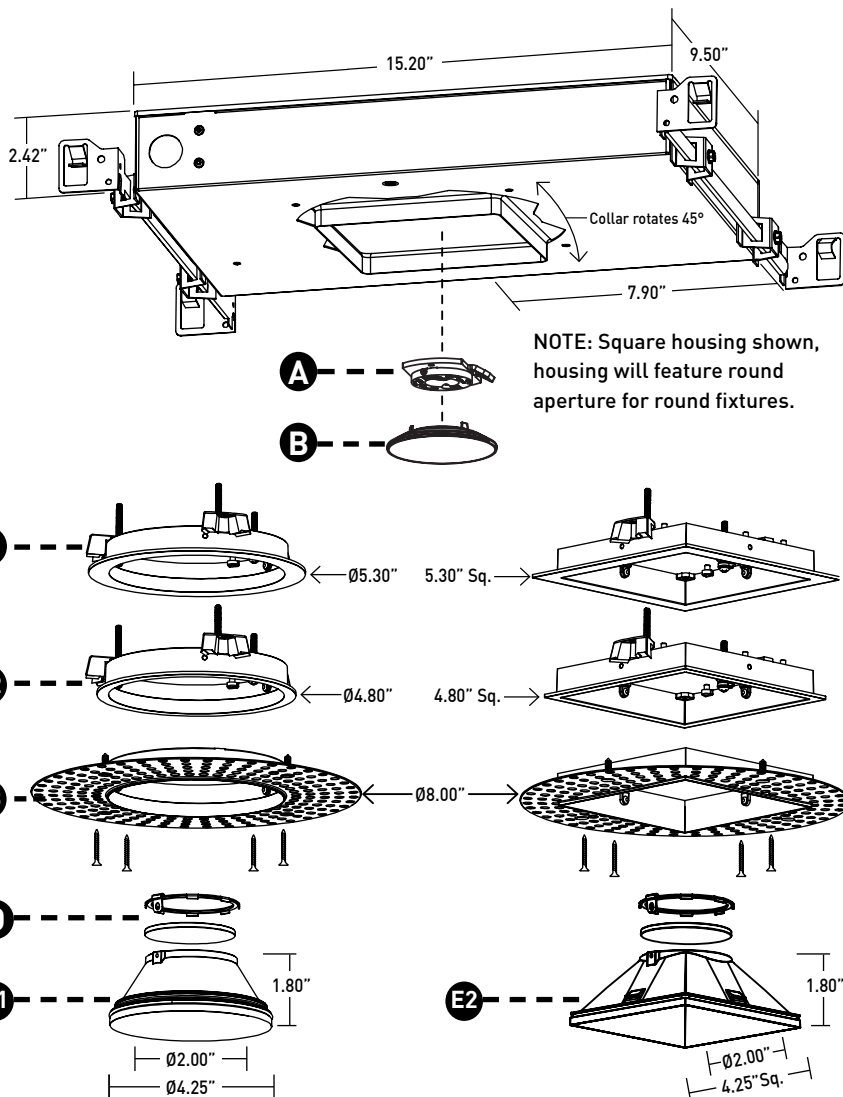

FRAZION4 SLIM DEEP REGRESS FIXED

DOWNLIGHT / HOUSING

- F TRIMLESS APPLIQUÉ DETAIL**
Integrated appliqué for plaster floating directly to baffle.
- G TG BRACKET ASSEMBLY**
Adjustable height bracket assembly provided with ceiling thickness "T" and recommended for installations in T-Grid and with furring channel. Hanger bars are installed to adjustable bracket. Allows housing to be raised and lowered; ceiling thickness remains 0.5" to 1.0" max.
- H IC HOUSING**
 - For IC ceilings.
 - CCEA, Airtight and Title 24 (JA8) listed.
 - Accommodates max 1711 delivered lumens.
 - No setback from polycell spray foam insulation having max R-Value of 60 on all sides and top of housing.
- I NIC HOUSING**
 - Minimum 0.50" setback from combustible and non-combustible materials on all sides and top of housing.
 - Minimum 3.00" setback from insulation material having max R-Value 30 on all sides and top of housing.
 - Minimum 6.00" setback from polycell spray foam insulation having max R-Value 60.
- J ATHENA / CASAMBI CONTROL**
Controls integrated into housing assembly. All equipment is serviceable.

Athena Model Numbers: A-WN-D01-RF-BL & DFC-OEM-DBI

Casambi Model Number: BT-S1E1-5400

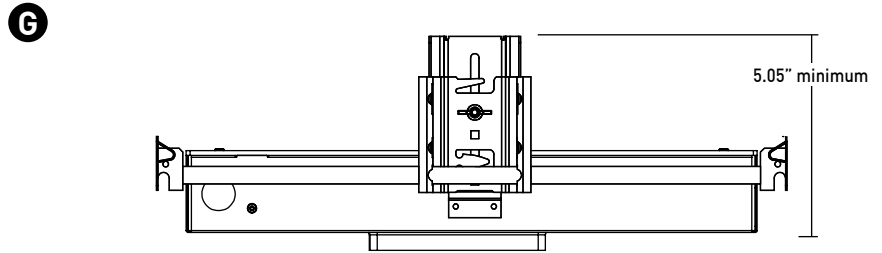
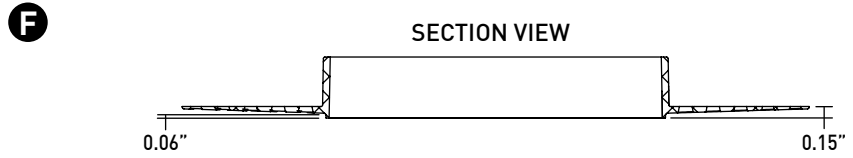

H / I



IC / NIC HAVE SAME DIMENSIONS AND NIC FEATURES VENTS

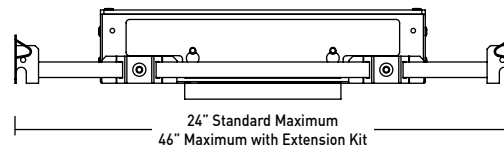

HOUSING NOTES

- Do not install in environments where ambient temperatures exceed 40°C (104°F).
- Power supply compartment and all splice connections may be serviced from room side.
- Consult factory for spacing requirements for any installations exceeding R-Value 60.
- Hanger bars fitted to short side of housing, and long side of Low Flux housings; extend from 14.0" to 24.0", but may be field cut to accommodate narrow stud spacing. Can be extended up to 46" maximum with FRX-HBE-46 kit.
- Hanger bars and brackets add 4.00" to the overall dimension, but are excluded from the setback requirements.
- Housings for round trims feature a round aperture housing collar, and for square trims, a square housing collar, accommodating ceiling thicknesses between 0.50" and 1.00".

FRACTION4 SLIM DEEP REGRESS FIXED

REMOTE POWER SUPPLY

- K REMOTE POWER SUPPLY**
- Provided with install Types "V", "W" and "D".
 - Requires plenum rated Class 2 cable between fixture and remote driver. Cable supplied by others.
 - See page 8 for maximum allowable wiring distance.
 - Must be installed in an accessible location
 - Do not install in environments where ambient temperatures exceed 40°C (104°F).

- L ATHENA / CASAMBI CONTROL**
- Controls integrated into remote driver assembly. All equipment is serviceable.

Athena Model Numbers: A-WN-D01-RF-BL & DFC-OEM-DBI

Casambi Model Number: BT-S1E1-5400

- M ATHENA / CASAMBI EM SHUNT**
- Included with drivers specified as ASR, ATR, CSR, or CTR. One required for each wireless EM fixture, requires class 2 control wiring between fixture and shunt. Features integrated test switch.

Model Number: PS-RMT-SHUNT

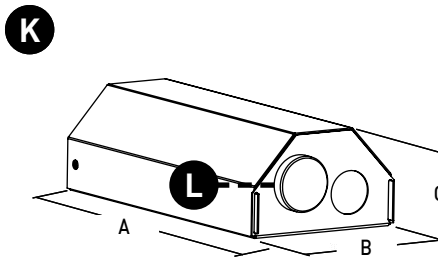

	A	B	C
<30W STATIC WHITE / WARM DIM	6.94"	3.35"	2.00"
30W STATIC WHITE	8.10"	5.00"	2.00"
TUNABLE WHITE	8.10"	5.00"	2.00"
ATHENA / CASAMBI CONTROLLED	8.10"	5.00"	2.00"

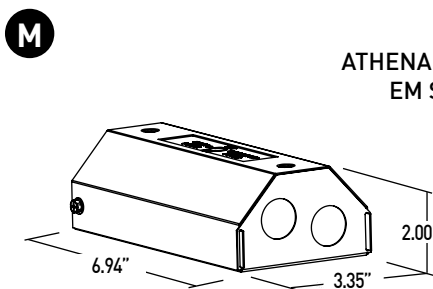

ATHENA / CASAMBI EM SHUNT

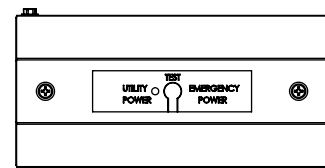

FRAXION4 SLIM DEEP REGRESS FIXED

TECHNICAL

CONSTRUCTION

Downlight: Painted finishes are granulated powder coat.

Housing: Aluminum and 22 Gauge galvanized steel. Extruded aluminum housing panel to act as heat-sink.

Remote Power Supply: 22 Gauge galvanized steel.

Appliqué: Zinc Alloy

STATIC WHITE LED

2-step MacAdam ellipse LED module available in 80+, 90+ and 97+ CRI configurations in color temperatures of 2700K, 3000K, 3500K and 4000K. 3-step MacAdam ellipse LED module available in 90+ CRI configuration in color temperature of 2400K. Average rated lamp life of 50,000 hours. LED and driver assemblies are field-replaceable.

WARM DIM LED

3-step MacAdam ellipse warm dim LED module available in 90+ CRI configuration. 3000K or 2700K at full brightness, warming to 1800K at full dim. Average rated lamp life of 50,000 hours. LED and driver assemblies are field-replaceable.

TUNABLE WHITE LED

3-step MacAdam ellipse tunable white LED module available in 90+ CRI configuration. Features tuning ranges of 1800K to 4000K and 2700K to 5000K. Average rated lamp life of 50,000 hours. LED and driver assemblies are field-replaceable.

POWER SUPPLY PERFORMANCE AND DIMMING INFORMATION

	ELV		ECO		0-10V						DALI-2			ATHENA		CASAMBI	
Power Supply	TR2	L23	LH1	LP1	AN4	LN2	EA2	LA2	DL1	DG1	ED1	LD1	DD1	AS	AD	CS	CD
Minimum °C	-20 °C	0 °C	0 °C	0 °C	-20 °C	-20 °C	-20 °C	-20 °C	-20 °C	-20 °C	-20 °C	-20 °C	-20 °C	0 °C	0 °C	-20 °C	-20 °C
Maximum °C	40 °C	40 °C	40 °C	40 °C	40 °C	40 °C	40 °C	40 °C	40 °C	40 °C	40 °C	40 °C	40 °C	40 °C	40 °C	40 °C	40 °C
Dimming %	2.0%	1.0%	1.0%	0.1%	1.0%	1.0%	0.1%	0.1%	0.1%	0.1%	0.1%	0.1%	0.1%	0.1%	0.1%	0.1%	0.1%

Note: For TR2, L23, LH1, LP1, AN4, EA2 and LA2 drivers consult chart on page 9 to confirm appropriate dimming curve for compatibility with selected control.

MAXIMUM ALLOWABLE REMOTE DRIVER WIRING DISTANCES

DRIVER	WIRE AWG				
	12	14	16	18	20
TR2, AN4, LN2	285'	180'	113'	71'	45'
L23, LH1, LP1	60'	40'	25'	15'	-
EA2, LA2, ED1, LD1, DG1, DL1, DD1, AS, AD, CS, CD	-	-	118'	72'	46'

LISTING

cTUVus listed to UL1598 standard for Dry / Damp and Wet locations.

CCEA, Airtight and Title 24 JA8-2022 Listed.

NEMA 410 Compliant.

U.S. Patent: 10,317,066

BUY AMERICAN ACT

All Fraxion4 Slim Deep Regress Adjustable configurations are Buy American Act compliant.

DECLARE

LBC Red List Approved.

WEIGHT

Fixture - 6.4 lbs max

Remote Driver - 1.4 lbs max

LIMITED WARRANTY

Manufacturer's Limited Warranty guarantees product(s) listed to be free from defects in material and workmanship under normal use and service for 1-year. LED and power supplies are warranted to operate with 70% of original flux and remain within a range of 3 duv for a period of 5-years.

10-year Lutron Advantage limited warranty available on Lutron equipped systems. Warranty period begins from the date of shipment by Seller.

Consult website for full warranty terms and conditions.

CHANGE LOG

1. 10/17/2022: REMOVED 90W13A 3200K-1800K WARM DIM AND ADDED 90W12A 3000K-1800K WARM DIM.

2. 04/26/2023: ADDED DECLARE LBC RED LIST APPROVED.

3. 08/08/2023: ADDED NEW LED AND OPTIC SYSTEM.

4. 02/08/2024: ADDED ATHENA AND CASAMBI CONTROL OFFERING, 2400K, AND WARM PROFILE TUNABLE WHITE.

FRACTION4 SLIM DEEP REGRESS FIXED

DIMMING COMPATIBILITY

PHILIPS DRIVER COMPATIBILITY

Power supply TR2 Manufacturer	Family/Model #
Lutron Electronics	DV-600P
Lutron Electronics	DVELV-303P
Lutron Electronics	NTELV-600
Lutron Electronics	MAELV-600
Lutron Electronics	SELV-300P
Lutron Electronics	DVLV-600P
Lutron Electronics	NFTU-5A
Lutron Electronics	CTCL-153P
Lutron Electronics	GL-600H
Lutron Electronics	S-600P
Lutron Electronics	PHPM
Power supply AN4 Manufacturer	Family/Model #
Lutron Electronics	DVTV plus PP-DV
Lutron Electronics	DVSCTV plus PP-DV
Lutron Electronics	DVSTV
Lutron Electronics	DVSCSTV
Lutron Electronics	QSGRJ-XP plus GRX-TVI
Lutron Electronics	QSGRJ-XE plus GRX-TVI
Lutron Electronics	QSGR-XE plus GRX-TVI
Lutron Electronics	NFTV plus PP-DV
Lutron Electronics	NTSTV
Lutron Electronics	RMJ-5T
Lutron Electronics	RMJS-8T
Lutron Electronics	FCJS-010
Leviton	IlumaTch IP7 series
Philips	Sunrise - SR1200ZTUNV

LUTRON DRIVER COMPATIBILITY

Power supply L23 Lutron Product Family	Part No.
Maestro WirelessR 600 W dimmer	MRF2-6ND-120-
Maestro WirelessR 1000 W dimmer	MRF2-10ND-120-
Caséta® Wireless Pro 1000 W dimmer	PD-10NXD-
GRAFIK T™ CL® dimmer	GT-250M-GTJ-250M-
HomeWorks® QS adaptive dimmer	HQRD-6NA-
HomeWorks® QS 600 W dimmer	HQRD-6ND-
HomeWorks® QS 1000 W dimmer	HQRD-10ND-
RadioRA® 2 adaptive dimmer	RRD-6NA-
RadioRA® 2 1000 W dimmer	RRD-10ND
myRoom™ DIN power module	MQSE-4A1-D
HomeWorks® QS DIN power module	LQSE-4A1-D
HomeWorks® QS wallbox power module	HQRJ-WPM-6D-120
HomeWorks® wallbox power module	HWI-WPM-6D-120
GRAFIK Eye® QS control unit	QSGR-, QSGRJ-
GRAFIK Eye® 3000 control unit	GRX-3100-GRX-3500-
RPM-4U module (LCP, HomeWorks® QS, GRAFIK Systems™, Quantum®)	HW-RPM-4U-120 LP-RPM-4U-120
RPM-4A module (LCP, HomeWorks® QS, GRAFIK Systems™, Quantum®)	HW-RPM-4A-120, LP-RPM-4A-120
GP dimming panels	Various
Ariadni CL 250W dimmer	AYCL-253P-
Diva CL 250W dimmer	DVCL-253P-DCSCCL-253P-
Nova T CL 250W dimmer	NTCL-250-
Power supply LH1 & LP1 Lutron Product Family	Part No.
PowPak Dimming Modules	RMJ-ECO32-DV-B
PowPak Dimming Modules	FCJ/FCJS-ECO
Energi Savr Nodes	QSN-1ECO-S
GRAFIK Eye QS control unit	QSN-2ECO-S
Homeworks QS control unit	QSGRJ- _E (wireless) QSGR- _E
Quantum Hub	QP2-__ 2C
Quantum Hub	QP2-__ 4C
Quantum Hub	QP2-__ 6C
Quantum Hub	QP2-__ 8C
Homeworks QS power module	LQSE-2ECO-D
myRoom Plus power module	

eldoLED DRIVER COMPATIBILITY

Power supply EA2 Manufacturer	Family/Model #
Busch-Jaeger	2112U-101
Jung	240-10
Leviton Lighting Controls	IP710-DLX
Lightolier Controls	ZP600FAM120
Merten	5729
Pass & Seymour	CD4FB-W
The Watt Stopper	DCLV1
Synergy	ISD BC
Crestron®	GLX-DIMFLV8
Crestron®	GLXP-DIMFLV8
Crestron®	GLPAC-DIMFLV4-*
Crestron®	GLPAC-DIMFLV8-*
Crestron®	GLPP-DIMFLVEX-PM
Crestron®	GLPP-1DIMFLV2EX-PM
Crestron®	GLPP-1DIMFLV3EX-PM
Crestron®	DIN-A08
Crestron®	DIN-4DIMFLV4
Crestron®	CLS-EXP-DIMFLV
Crestron®	CLCI-1DIMFLV2EX
Power supply LA2 Manufacturer	Family/Model #
Lutron Electronics	Nova T® - NTFTV
Lutron Electronics	Diva® - DVTV
Lutron Electronics	Nova® - NFTV
Lutron Electronics	GrafixEye® GRX-TVI w GRX3503
Lutron Electronics	Energy Savr Node™ - QSN-4T16-S
Lutron Electronics	TVM2 Module
Sensor Switch	nIO EZ
ABB	SD/S 2.16.1

ANALOG DRIVERS AND DIMMERS

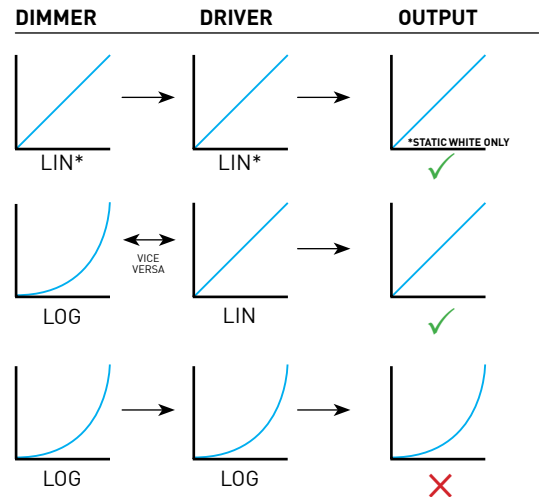

LIN = LINEAR
 LOG = LOGARITHMIC
 *LIN-TO-LIN NOT COMPATIBLE FOR WARM-DIM OR TUNABLE WHITE

