

CYLINDER 3 SURFACE MOUNT

Our best-selling cylinders keep getting better. Adjustable, fixed, and wallwash are all offered in a broad range of sizes, with lumens from 500 to almost 5000lm, standard 90° tilt, and more than a dozen finish options. Now, there's a fixture for anywhere you need to illuminate anything.

PROJECT NAME:	TYPE:
---------------	-------

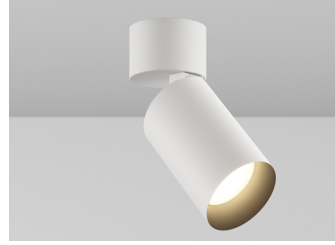

ORDERING INFORMATION



Quick Ship Product. All rough in components ship within 10 days up to quantities of 100.



JAB-2022 COMPLIANCE INDICATED BY SHADING

CYLINDER	FUNCTION	RATING	CYLINDER FINISH	BAFFLE FINISH	CRI / WATTAGE PACKAGE	CCT	OPTIC (UGR)	MEDIA	POWER SUPPLY	MOUNTING
CY3X										
CY3X 3.91" Ø	AD 90° Adjustable AS 90° Adjustable Shallow Canopy* <small>*(Remote driver only)</small> AW Adjustable Wallwash FB Fixed WW Wallwash Fixed	1 Dry / Damp (IP30) 2 Wet (IP65)	POWDERCOAT FINISHES WH White AG Satin Silver AU Cashmere Gold AB Architectural Bronze BB Burnt Bronze BK Black CF Custom Finish* <small>*(Consult Factory)</small> ALUMINA FINISHES 01 Brushed Obsidian 02 Matte Obsidian 03 Brushed Dark Patinated Bronze 04 Matte Dark Patinated Bronze 05 Brushed Aged Aluminum 06 Matte Aged Aluminum 07 Brushed Cast Brass 08 Matte Cast Brass 09 Brushed Light Patinated Bronze 10 Matte Light Patinated Bronze FINISH IMAGES ON PAGE 2	POWDERCOAT FINISHES WH White AG Satin Silver AU Cashmere Gold AB Architectural Bronze BB Burnt Bronze BK Black CF Custom Finish* <small>*(Consult Factory)</small> ALUMINA FINISHES 01 Brushed Obsidian 02 Matte Obsidian 03 Brushed Dark Patinated Bronze 04 Matte Dark Patinated Bronze 05 Brushed Aged Aluminum 06 Matte Aged Aluminum 07 Brushed Cast Brass 08 Matte Cast Brass 09 Brushed Light Patinated Bronze 10 Matte Light Patinated Bronze FINISH IMAGES ON PAGE 2	STATIC WHITE 80S11B 80+ CRI, 11 Watts Lm. Delivered - 1240 80S17B 80+ CRI, 17 Watts Lm. Delivered - 1943 80S23B 80+ CRI, 23 Watts Lm. Delivered - 2559 80S32B 80+ CRI, 32 Watts Lm. Delivered - 3372 80S38B* 80+ CRI, 38 Watts Lm. Delivered - 3932 <small>*(Remote driver required)</small> 90S11B 90+ CRI, 11 Watts Lm. Delivered - 1060 90S17B 90+ CRI, 17 Watts Lm. Delivered - 1661 90S23B 90+ CRI, 23 Watts Lm. Delivered - 2187 90S32B 90+ CRI, 32 Watts Lm. Delivered - 2882 90S38B* 90+ CRI, 38 Watts 3361 Lm. Delivered - 3361 <small>*(Remote driver required)</small> 97S11B 97+ CRI, 11 Watts Lm. Delivered - 975 97S17B 97+ CRI, 17 Watts Lm. Delivered - 1528 97S23B 97+ CRI, 23 Watts Lm. Delivered - 2012 97S32B 97+ CRI, 32 Watts Lm. Delivered - 2651 97S38B* 97+ CRI, 38 Watts Lm. Delivered - 3092 <small>*(Remote driver required)</small> WARM DIM 90W23B 90+ CRI, 23 Watts Incandescent Profile Lm. Delivered - 1642 Halogen Profile Lm. Delivered - 1777 <small>*SEE PAGE 3 FOR DETAILED PERFORMANCE CONFIGURATIONS AND WARM DIM PROFILE COMPARISON.</small> TUNABLE WHITE (REMOTE DRIVER ONLY) 90T32B 90+ CRI, 32 Watts Warm Profile Lm. Delivered - 2325 Cool Profile Lm. Delivered - 2580 <small>*ALL DELIVERED LUMEN OUTPUTS AND T24 COMPLIANCE REFLECT 3000K PAIRED WITH 20° OPTIC AND SOFT FOCUS LENS.</small>	24 2400K* <small>*90+CRI only</small> 27 2700K 30 3000K 35 3500K 40 4000K WL 2700K - 1800K WD 3000K - 1800K TR 4000K - 1800K TH 5000K - 2700K	10 10° (<10) <small>*(11/17 Watts only)</small> 15 15° (<13) 20 20° (<10) 25 25° (<10) 40 40° (<10) 60 60° (<13) WW Wallwash* <small>*(Required for WW & AW fixture)</small> W Wallwash Lens* <small>*(Required for WW and AW fixture)</small> WW Wallwash* <small>*(Required for WW & AW fixture)</small> WW Wallwash* <small>*(Required for WW & AW fixture)</small> <small>*SEE PAGE 4 FOR UGR VALUES</small>	STANDARD MEDIA 4 Soft Focus Lens (SFL) 0 No Lens* <small>*(Recommended for 10° optic, not available for Warm Dim or Wet Location)</small> ALTERNATE MEDIA 2 Honey Comb Louver (HCL)* <small>*(Not available for Warm Dim or Wet Location)</small> 3 Clear Glass Lens (CGL)* <small>*(Not available for Warm Dim or Wet Location)</small> 5 Frosted Glass Lens (FGL) 6 Frosted Soft Focus Lens (FSFL) 7 Frosted Linear Spread Lens (FLSL) C Clear Glass Lens w/ Linear Spread Lens H Soft Focus Lens w/ Honeycomb Louver W Wallwash Lens* <small>*(Required for WW and AW fixture)</small> WW Wallwash* <small>*(Required for WW & AW fixture)</small>	INTEGRAL UCA 0-10V Analog 120-277V 1CE 120V Electronic Forward/Reverse REMOTE (120V) 1TR Philips, 2% Forward/Reverse* <small>*(11 & 17 Watts only)</small> 1L2 Lutron Hi-Lume 1%, 2-Wire 1RE Forward/Reverse REMOTE (120-277V) URA 0-10V Analog ULH Lutron Hi-Lume Ecosystem 1% Fade to Black UAN Philips Titanium 1% 0-10V, LOG ULN Philips Titanium 1% 0-10V, LIN UEG eldoLED, SOLOdrive 0.1% 0-10V, LOG UEN eldoLED, SOLOdrive 0.1% 0-10V, LIN UED eldoLED, SOLOdrive 0.1% DALI-2, LOG ULD eldoLED, SOLOdrive 0.1% DALI-2, LIN UAS/ Athena Control UAR EldoLED, SOLOdrive 0.1% 120-277V* UCS/Casambi Control UCR EldoLED, SOLOdrive 0.1% 120-277V* <small>*Includes Node. Extended lead time, consult factory for EM use!</small> TUNABLE WHITE REMOTE (0.1%, 120-277V) UDD eldoLED, DUALdrive DALI-2, LOG UDG eldoLED, DUALdrive 0-10V, LOG UDN eldoLED, DUALdrive 0-10V, LIN UAD1/ Athena Control, DUALdrive* UADR EldoLED, DUALdrive* UCD1/ Casambi Control, DUALdrive* UCDR EldoLED, DUALdrive* <small>*Includes Node. Extended lead time, consult factory for EM use!</small>	ROUGH-IN JBMP 4" Sq. or 4/0 Junction Box Mounting Plate FINISH OUT CMJB *1/2" and 3/4" Conduit Ceiling Mount Junction Box* <small>*(Available in powdercoat finishes. Alumina finish fixtures ship with Black powdercoat CMJB.)</small> SMK3 3/0 Surface Mount Kit* SMK4 4/0 Surface Mount Kit* <small>*(Dry/Damp rated)</small>

PART NUMBER NOTES

- CY3X ships as e.g., CY3XAD1WHWH80S17A304041CE3
- Remote driver ships as e.g., PS-RMT-80S17A-1RE3
- Mounting part numbers listed on page 6



CYLINDER 3 SURFACE MOUNT

ACCESSORIES

ALTERNATE MEDIA

- SFL-CY3X-03** Soft Focus Lens
- HCL-CY3X-03** Honeycomb Louver *
- CGL-CY3X-03** Clear Glass Lens *
- FGL-CY3X-03** Frosted Glass Lens
- FSFL-CY3X-03** Frosted Soft Focus Lens
- FLSL-CY3X-03** Frosted Linear Spread Lens
- CGL-LSL-CY3X-03** Clear Glass Lens W/ Linear Spread Lens*
- SFL-HCL-CY3X-03** Soft Focus Lens W/ Honeycomb Louver*

STATIC WHITE REPLACEMENT OPTICS

- RO-70-15-S** 15° optic
- RO-70-20-S** 20° optic
- RO-70-25-S** 25° optic
- RO-70-40-S** 40° optic
- RO-70-60-S** 60° optic

WARM DIM REPLACEMENT OPTICS

- RO-70-20-W** 20° optic
- RO-70-25-W** 25° optic
- RO-70-40-W** 40° optic
- RO-70-60-W** 60° optic

TUNABLE WHITE REPLACEMENT OPTICS

- RO-70-15-T** 15° optic
- RO-70-20-T** 20° optic
- RO-70-25-T** 25° optic
- RO-70-40-T** 40° optic
- RO-70-60-T** 60° optic

EMERGENCY LIGHTING - REMOTE MOUNT ONLY

During disruption of main power, emergency battery inverter provides temporary 120V or 277V to fixture.

- EMB-S-25-120/277-LEDX** 25 watt max capacity, 120 or 277 VAC 60Hz
- EMB-S-100-120-LEDX** 100 watt max capacity, 120 VAC 60Hz, 0-10V dimmable
- EMB-S-100-277-LEDX** 100 watt max capacity, 277 VAC 60Hz, 0-10V dimmable
- EMB-S-250-120/277-LEDX** 250 watt max capacity, 120 or 277 VAC 60Hz

***SHUNT REQUIRED FOR USE WITH ATHENA AND CASAMBI CONTROLS, CONSULT FACTORY FOR DETAILS.**

POWDERCOAT FINISHES



ALUMINA FINISHES BY LUCIFER LIGHTING™



CYLINDER 3 SURFACE MOUNT

WALLWASH DESIGN GUIDE



10° TILT

30" SETBACK / 30" ON CENTER SPACING

- 10FT CEILING SHOWN / 8-12FT IDEAL
- AVERAGE FC: 59.81
- MAX / MIN: 6.11
- 9 FIXTURES / 25FT WALL SHOWN



RECOMMENDED

15° TILT

36" SETBACK / 36" ON CENTER SPACING

- 10FT CEILING SHOWN / 8-12FT IDEAL
- AVERAGE FC: 52.90
- MAX / MIN: 5.47
- 9 FIXTURES / 30FT WALL SHOWN

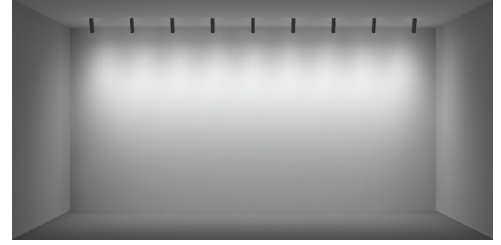

20° TILT

42" SETBACK / 42" ON CENTER SPACING

- 10FT CEILING SHOWN / 8-12FT IDEAL
- AVERAGE FC: 47.58
- MAX / MIN: 5.10
- 9 FIXTURES / 35FT WALL SHOWN

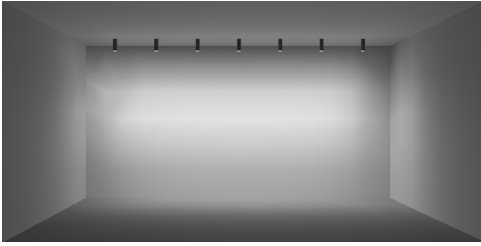

30" SETBACK / 42" ON CENTER SPACING

- 10FT CEILING SHOWN / 8-12FT IDEAL
- AVERAGE FC: 38.76
- MAX / MIN: 6.49
- 9 FIXTURES / 25FT WALL SHOWN

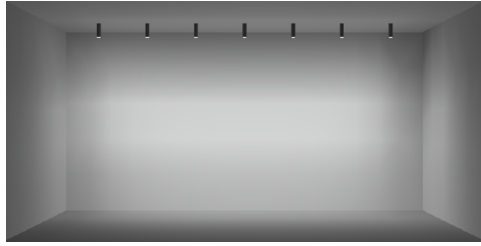

RECOMMENDED

36" SETBACK / 48" ON CENTER SPACING

- 10FT CEILING SHOWN / 8-12FT IDEAL
- AVERAGE FC: 31.26
- MAX / MIN: 6.32
- 9 FIXTURES / 30FT WALL SHOWN

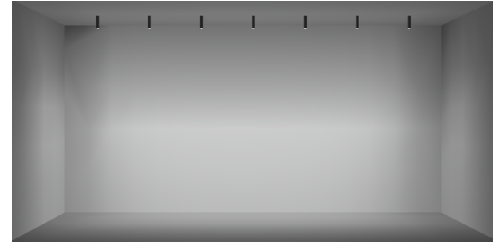

42" SETBACK / 54" ON CENTER SPACING

- 10FT CEILING SHOWN / 8-12FT IDEAL
- AVERAGE FC: 25.34
- MAX / MIN: 6.22
- 9 FIXTURES / 35FT WALL SHOWN

ADDITIONAL SETBACKS AND SPACINGS

ON CENTER SPACING	SETBACK / TILT			ON CENTER SPACING	SETBACK		
	30" / 10°	36" / 15°	42" / 20°		30"	36"	42"
30"	SHOWN ABOVE	AVERAGE FC: 61.83 MAX / MIN: 5.46	AVERAGE FC: 63.70 MAX / MIN: 5.22	42"	SHOWN ABOVE	AVERAGE FC: 34.94 MAX / MIN: 6.44	AVERAGE FC: 31.32 MAX / MIN: 6.35
36"	AVERAGE FC: 51.17 MAX / MIN: 6.25	SHOWN ABOVE	AVERAGE FC: 54.57 MAX / MIN: 5.10	48"	AVERAGE FC: 34.66 MAX / MIN: 6.34	SHOWN ABOVE	AVERAGE FC: 28.02 MAX / MIN: 6.22
42"	AVERAGE FC: 44.58 MAX / MIN: 6.55	AVERAGE FC: 46.13 MAX / MIN: 5.63	SHOWN ABOVE	54"	AVERAGE FC: 31.32 MAX / MIN: 6.57	AVERAGE FC: 28.22 MAX / MIN: 6.36	SHOWN ABOVE

***ALL DATA REFLECTS 90S17B WATTAGE PACKAGE**

CYLINDER 3 SURFACE MOUNT

STATIC WHITE PERFORMANCE - 3000K

LUMEN PACKAGE	WATTAGE	10° OPTIC NO LENS		15° OPTIC SOFT FOCUS LENS		20° OPTIC SOFT FOCUS LENS		25° OPTIC SOFT FOCUS LENS		40° OPTIC SOFT FOCUS LENS		60° OPTIC SOFT FOCUS LENS		WALLWASH WALLWASH LENS		ADJ. WALLWASH WALLWASH LENS	
		DLVD	LPW	DLVD	LPW	DLVD	LPW	DLVD	LPW	DLVD	LPW	DLVD	LPW	DLVD	LPW	DLVD	LPW
80S11B	11	950	86	1169	106	1240	112	1243	112	1185	107	1156	105	979	89	1137	103
80S17B	17	1357	79	1171	104	1943	114	1931	113	1858	109	1801	105	1509	88	1783	104
80S23B	23	-	-	2301	100	2559	111	2541	110	2409	104	2373	103	2039	88	2312	100
80S32B	32	-	-	2913	91	3372	105	3339	104	3170	99	3111	97	2641	82	3042	95
80S38B	38	-	-	3226	84	3932	103	3856	101	3680	96	3614	95	3072	80	3531	92
90S11B	11	812	73	1008	91	1060	96	1062	96	1013	92	988	89	837	76	972	88
90S17B	17	1160	68	1527	89	1661	97	1650	97	1588	93	1539	90	1290	75	1524	89
90S23B	23	-	-	1984	86	2187	95	2172	94	2059	89	2028	88	1743	75	1976	85
90S32B	32	-	-	2511	78	2882	90	2854	89	2709	84	2659	83	2257	70	2600	81
90S38B	38	-	-	2781	73	3361	88	3296	86	3121	82	3089	81	2626	69	3018	79
97S11B	11	747	67	887	80	975	88	977	88	932	84	909	82	770	70	894	81
97S17B	17	1067	62	1344	79	1528	89	1518	89	1461	85	1416	83	1187	69	1402	82
97S23B	23	-	-	1746	75	2012	87	1998	86	1894	82	1866	81	1604	69	1818	79
97S32B	32	-	-	2210	69	2651	82	2626	82	2492	77	2446	76	2076	64	2392	74
97S38B	38	-	-	2447	64	3092	81	3032	79	2893	76	2842	74	2416	63	2777	73
90W23BL (2700K-1800K)	23	-	-	-	-	1642	71	1626	70	1556	67	1491	64	1340	58	1570	68
90W23BD (3000K-1800K)	23	-	-	-	-	1777	77	1742	75	1685	73	1600	69	1422	61	1668	72
90T32BTR (4000K-1800K)	32	-	-	2251	70	2325	72	2319	72	2359	73	2352	73	2072	64	2520	78
90T32BTH (5000K-2700K)	32	-	-	2458	76	2580	80	2533	79	2394	74	2291	71	2085	65	2401	75

MEDIA LIGHT LOSS FACTOR

MEDIA	LIGHT LOSS FACTOR
No Lens	1.07
CGL	0.99
SFL	1.00
FGL	0.88
FSFL	0.91
FLSL	0.81
HCL	0.71
SFL+HCL	0.66

OUTPUT MULTIPLIER

CCT	CCT SCALE
2400K	0.76
2700K	0.957
3000K	1.000
3500K	1.019
4000K	1.030

TUNABLE WHITE MULTIPLIER

CCT	5000K-2700K	4000K-1800K
5000K	1.16	-
4000K	1.08	1.14
3500K	1.04	1.07
3000K	1.00	1.00
2700K	0.96	0.92
2400K	-	0.84
1800K	-	0.69



JA8-2022 INDICATED BY SHADING

UNIFIED GLARE RATING

10° OPTIC NO LENS	15° OPTIC SOFT FOCUS LENS	20° OPTIC SOFT FOCUS LENS	25° OPTIC SOFT FOCUS LENS	40° OPTIC SOFT FOCUS LENS	60° OPTIC SOFT FOCUS LENS	WALLWASH WALLWASH LENS
<10	<13	<10	<10	<10	<13	>19

WARM DIM PERFORMANCE - SOFT FOCUS LENS - 20° OPTIC

INCANDESCENT DIMMING PROFILE

90W23BL 2700K - 1800K	Full on 100%	Dimmed to 80%	Dimmed to 70%	Dimmed to 50%	Dimmed to 20%	Dimmed to 10%	Dimmed to 2%
CCT (K)	2700	2650	2620	2520	2180	1950	1800
Light Output (Lm)	1642	1314	1149	821	328	164	33
Power (W)	23	18	16	12	5	2.3	0.5
Efficacy (LPW)	71	71	71	71	71	71	71

HALOGEN DIMMING PROFILE

90W23BD 3000K - 1800K	Full on 100%	Dimmed to 80%	Dimmed to 70%	Dimmed to 50%	Dimmed to 20%	Dimmed to 10%	Dimmed to 2%
CCT (K)	3000	2950	2920	2775	2375	2000	1800
Light Output (Lm)	1777	1422	1244	889	355	178	36
Power (W)	23	18	16	12	5	2.3	0.5
Efficacy (LPW)	74	74	74	74	74	74	74

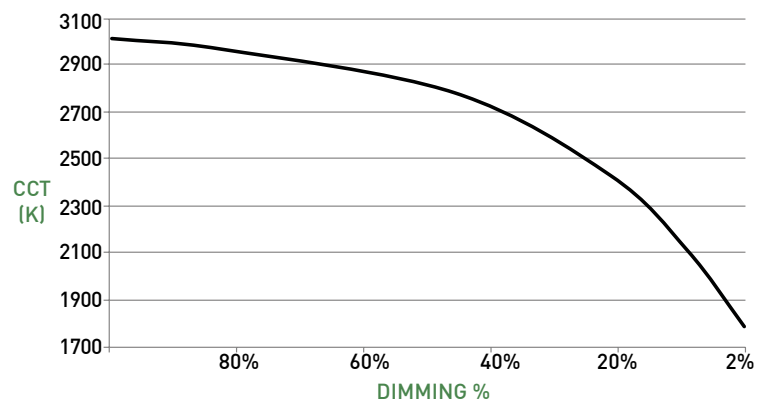
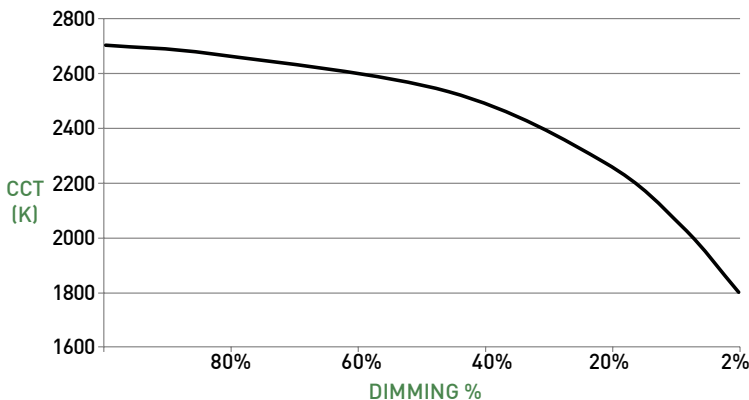

CYLINDER 3 SURFACE MOUNT

CYLINDER ASSEMBLY

- A ADJUSTABLE - STANDARD CANOPY**
Die-cast canopy accommodates flat and sloped ceiling conditions. Conceals hidden mounting hardware. "AD" (90° tilt, 365° rotation) canopy features 2.15" (55mm) tall canopy. Available with integral or remote driver.
- B ADJUSTABLE - SHALLOW CANOPY**
Die-cast canopy accommodates flat and slope ceiling conditions. Conceals hidden mounting hardware. "AS" (90° tilt, 365° rotation) canopy features 0.65" (17mm) tall canopy, reducing overall height. Requires remote power supply.
- C FIXED BODY**
Body with integrated heat sink and LED. Conceals mounting hardware. Power supply may be integral or remote mount.
- D WALLWASH FIXED BODY**
- E OPTICS**
Robust light engine with optimized optic pairing integrates Reflection, Refraction, and TIR offering 10°, 15°, 20°, 25°, 40° & 60° beams.
- F MEDIA**
Cylinder accepts 2 lenses; soft focus lens, no lens or wallwash lens standard. Sealed in place for Wet locations.
- G BAFFLE**
Die-cast baffle minimizes aperture glare and conceals view into fixture.
- H WALL-MOUNT**
Cylinder may be wall mounted using any mounting option.

DIMENSIONS / DRAWINGS

A ADJUSTABLE BODY STANDARD CANOPY

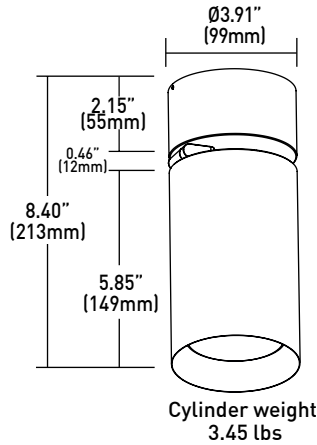

B ADJUSTABLE BODY SHALLOW CANOPY

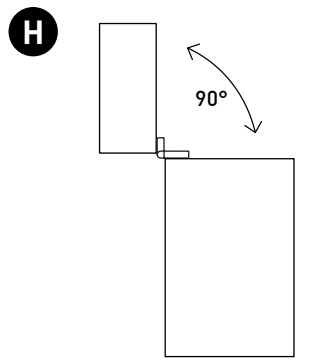
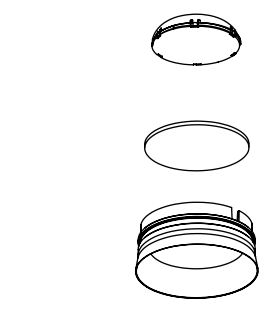
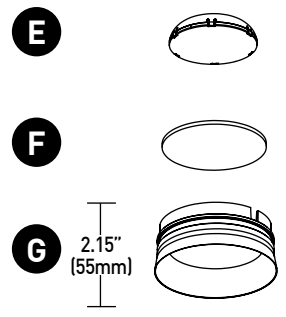
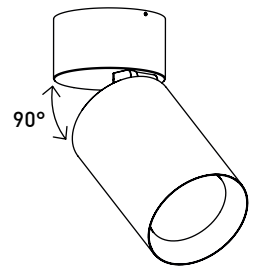
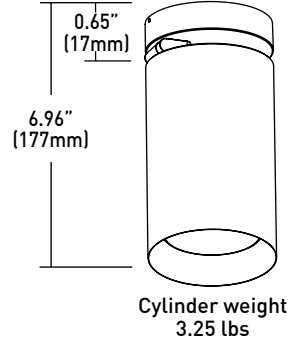

C FIXED BODY

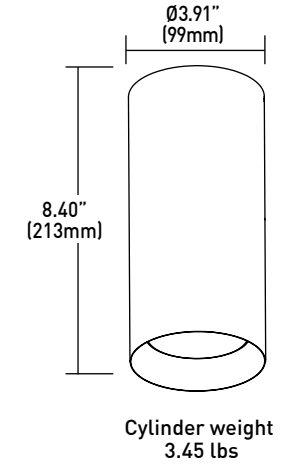

D WALLWASH FIXED BODY

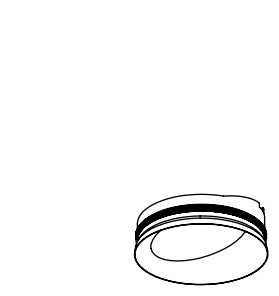
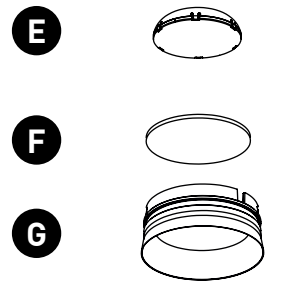
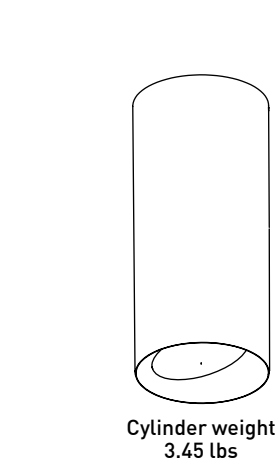

CYLINDER 3 SURFACE MOUNT

MOUNTING

- I JBMP**
Mounting plate (concealed) for standard 4" square or 4" 4/0 j-box. To be installed during rough-in prior to substrate. Fixture to mount flush with minimalist transition to ceiling.
Part Number - CY3X-JBMP
- J SMK3**
Surface mount kit includes mounting plate and 4" concealer plate that installs between fixture and standard 3" 3/0 j-box for existing applications where standard j-box cutout is to be concealed.
Part Number - CY3X-SMK-3/0-(FINISH)
- K SMK4**
Surface mount kit includes mounting plate and 5" concealer plate that installs between fixture and standard 4" 4/0 j-box for existing applications where standard j-box cutout is to be concealed.
Part Number - CY3X-SMK-4/0-(FINISH)
- L CMJB**
Ceiling mount junction box perfectly matches the cylinder profile for a continuous, integrated look where exposed ceiling mount junction box and conduit applications apply. For use with 1/2" and 3/4" EMT conduit only. Features two conduit entrances on either side and one conduit knockout on top of j-box. J-box is IP10 rated; painted finishes only. Blank off plugs included.
Part Number - CY3X-CMJB-(FINISH)

DIMENSIONS / DRAWINGS

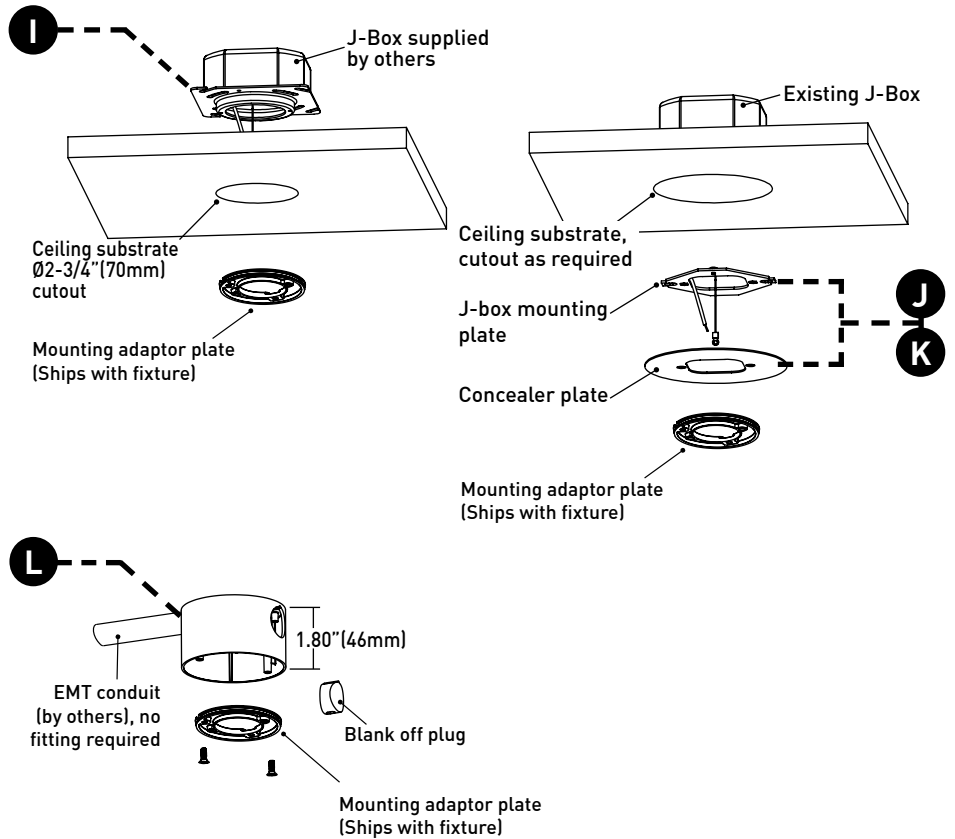

MOUNTING NOTES

- CY3X-JBMP and CY3X-SMK-3/0 & 4/0 not recommended for use with pancake style j-box.

REMOTE POWER SUPPLY

- M PS-RMT**
Remote power supply must be mounted in accessible area. Mounting device still required. Consult page 8 for dimming compatibility list. Consult install guide for complete details of suitable controls, wiring diagrams, and maximum allowable secondary run lengths between PS-RMT and cylinder.
- N ATHENA / CASAMBI CONTROL**
Controls integrated into remote driver assembly. All equipment is serviceable
Athena Model Number: A-WN-D01-RF-BL & DC-OEM-DBI
Casambi Model Number: BT-S1E1-5400
- O ATHENA / CASAMBI EM SHUNT**
Included with drivers specified as ASR, ADR, CSR, or CDR. One required for each wireless EM fixture, requires class 2 control wiring between fixture and shunt. Features integrated test switch.
Model Number: PS-RMT-SHUNT

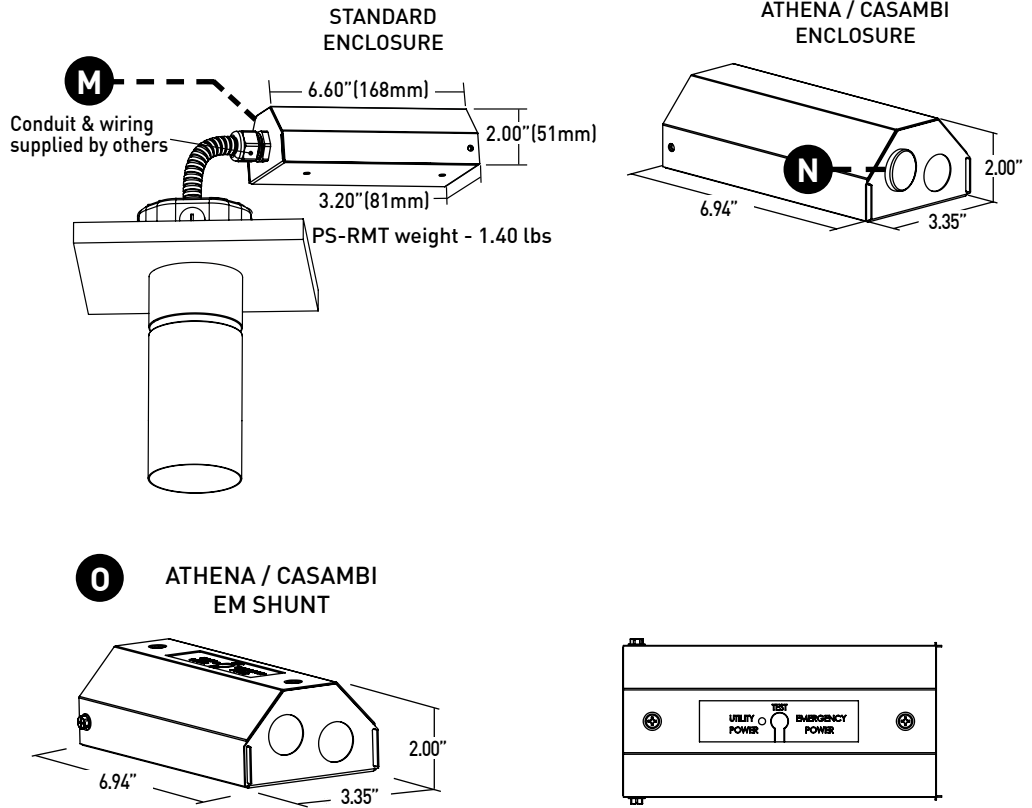

CYLINDER 3 SURFACE MOUNT

TECHNICAL

CONSTRUCTION

Cylinder: Die-cast aluminum body with integrated heat sink; painted finishes are granulated powder coat. Alumina finishes are anodized aluminum.

CMJB: Die-cast aluminum body; painted finishes are granulated powder coat.

Remote Power Supply: 22 Gauge galvanized steel.

STATIC WHITE LED

2-step MacAdam ellipse LED module available in 80+, 90+ and 95+ CRI configurations in color temperatures of 2700K, 3000K, 3500K and 4000K. 3-step MacAdam ellipse LED module available in 90+ CRI configuration in color temperature of 2400K. Average rated lamp life: 50,000 hours. LED and driver assemblies are field-replaceable.

WARM DIM LED

3-step MacAdam ellipse warm dim LED module available in 90+ CRI configuration. 3000K or 2700K at full brightness, warming to 1800K at full dim. Average rated lamp life of 50,000 hours. LED and driver assemblies are field-replaceable.

TUNABLE WHITE LED

3-step MacAdam ellipse tunable white LED module available in 90+ CRI configuration. Features tuning range of 2700K to 5000K and 1800K to 4000K. Average rated lamp life of 50,000 hours. Driver assemblies are field-replaceable.

POWER SUPPLY PERFORMANCE AND DIMMING INFORMATION

Power Supply	PHASE			0-10V								ECO	DALI			ATHENA	CASAMBI
	1CE/1RE	1TR	1L2	UCA/URA	UAN	ULN	UEG	UEN	UDG	UDN	ULH	UED	ULD	UDD	UAS/UAD	UCS/UCD	
Minimum °C	-20 °C	-20 °C	0 °C	-20 °C	-20 °C	-20 °C	-20 °C	-20 °C	-20 °C	-20 °C	0 °C	-20 °C	-20 °C	-20 °C	0 °C	-20 °C	
Maximum °C	40 °C	40 °C	40 °C	40 °C	40 °C	40 °C	40 °C	40 °C	40 °C	40 °C	40 °C	40 °C	40 °C	40 °C	40 °C	40 °C	
Dimming %	1.0%	2.0%	1.0%	1.0%	1.0%	1.0%	0.1%	0.1%	0.1%	0.1%	1.0%	0.1%	0.1%	0.1%	0.1%	0.1%	

Note: For 1TR, 1L2, ULH, UAN, ULN, UEG and UEN drivers consult chart on page 8 to confirm appropriate dimming curve for compatibility with selected control.

MAXIMUM ALLOWABLE REMOTE DRIVER WIRING DISTANCES

DRIVER	WIRE AWG				
	12	14	16	18	20
URA, 1RE	-	164'	105'	66'	40'
1TR, UAN, ULN	285'	180'	113'	71'	45'
1L2, ULH	60'	40'	25'	15'	-
UEG, UEN, UED, ULD, DD1, DG1, DN1, UAS, UCS, UAD, UCD	-	-	118'	72'	46'

WALLWASH SPACING AND TILT

Adjustable Wallwash Cylinder must be tilted to achieve wallwashing effect. Recommended adjustable spacing is 36" (914mm) on center with 36" (914mm) setback from wall plane with 15° tilt. Recommended fixed spacing is 36" (914mm) on center spacing with 48" (1219mm) setback from wall plane.

MOUNTING

Cylinder is supplied with a mounting adaptor plate, which integrates with required additional mounting accessories specified separately according to field application conditions, providing a minimalist transition from standard 4/0 or 4" square junction boxes and accommodating ceiling thicknesses of 0.44" (12mm) to 0.75" (19mm). Ceiling-mount junction box available for 1/2" (13mm) and 3/4" (19mm) conduit and feature concealed internal clamps for clean fitting-free conduit exit and entry.

LISTING

cTUVus listed to UL1598 standard for Dry / Damp (IP30) and Wet (IP65) location. Title 24 JA8-2022 Listed. NEMA 410 Compliant. Buy American Act compliant.

DECLARE

LBC Red List Approved

WARRANTY

Manufacturer's 1-year warranty guarantees product(s) listed to be free from defects in material and workmanship under normal use and service. 5-year warranty on LED and power supply to operate with 70% of the original flux and remain within a range of 3 duv. 10-year Lutron Advantage limited warranty available on Lutron equipped systems. Warranty period begins from the date of shipment by Seller. Consult [website](#) for full warranty terms and conditions.

CYLINDER 3 SURFACE MOUNT

DIMMING COMPATIBILITY

PHILIPS DRIVER COMPATIBILITY

Power supply 1TR Manufacturer	Family/Model #
Lutron Electronics	DV-600P
Lutron Electronics	DVELV-303P
Lutron Electronics	NTELV-600
Lutron Electronics	MAELV-600
Lutron Electronics	SELV-300P
Lutron Electronics	DVLV-600P
Lutron Electronics	NFTU-5A
Lutron Electronics	CTCL-153P
Lutron Electronics	GL-600H
Lutron Electronics	S-600P
Lutron Electronics	PHPM
Power supply UAN / ULN Manufacturer	Family/Model #
Lutron Electronics	DVTV plus PP-DV
Lutron Electronics	DVSCTV plus PP-DV
Lutron Electronics	DVSTV
Lutron Electronics	DVSCSTV
Lutron Electronics	QSGRJ-XP plus GRX-TVI
Lutron Electronics	QSGRJ-XE plus GRX-TVI
Lutron Electronics	QSGR-XE plus GRX-TVI
Lutron Electronics	NFTV plus PP-DV
Lutron Electronics	NTSTV
Lutron Electronics	RMJ-5T
Lutron Electronics	RMJS-8T
Lutron Electronics	FCJS-010
Leviton	IlumaTch IP7 series
Philips	Sunrise - SR1200ZTUNV

LUTRON DRIVER COMPATIBILITY

Power supply 1L2 Lutron Product Family	Part No.
Maestro WirelessR 600 W dimmer	MRF2-6ND-120-
Maestro WirelessR 1000 W dimmer	MRF2-10ND-120-
Caséta® Wireless Pro 1000 W dimmer	PD-10NXD-
GRAFIK T™ CL® dimmer	GT-250M-GTJ-250M-
HomeWorks® QS adaptive dimmer	HQRD-6NA-
HomeWorks® QS 600 W dimmer	HQRD-6ND-
HomeWorks® QS 1000 W dimmer	HQRD-10ND-
RadioRA® 2 adaptive dimmer	RRD-6NA-
RadioRA® 2 1000 W dimmer	RRD-10ND
myRoom™ DIN power module	MQSE-4A1-D
HomeWorks® QS DIN power module	LQSE-4A1-D
HomeWorks® QS wallbox power module	HQRJ-WPM-6D-120
HomeWorks® wallbox power module	HWI-WPM-6D-120
GRAFIK Eye® QS control unit	QSGR-, QSGRJ-
GRAFIK Eye® 3000 control unit	GRX-3100-GRX-3500-
RPM-4U module (LCP, HomeWorks® QS, GRAFIK Systems™, Quantum®)	HW-RPM-4U-120 LP-RPM-4U-120
RPM-4A module (LCP, HomeWorks® QS, GRAFIK Systems™, Quantum®)	HW-RPM-4A-120, LP-RPM-4A-120
GP dimming panels	Various
Ariadni CL 250W dimmer	AYCL-253P-
Diva CL 250W dimmer	DVCL-253P-DCSCCL-253P-
Nova T CL 250W dimmer	NTCL-250-
Power supply ULH Lutron Product Family	Part No.
PowPak Dimming Modules	RMJ-ECO32-DV-B
PowPak Dimming Modules	FCJ/FCJS-ECO
Energi Savr Nodes	QSN-1ECO-S
GRAFIK Eye QS control unit	QSN-2ECO-S
Homeworks QS control unit	QSGRJ- _E (wireless) QSGR- _E
Quantum Hub	QP2-__ 2C
Quantum Hub	QP2-__ 4C
Quantum Hub	QP2-__ 6C
Quantum Hub	QP2-__ 8C
Homeworks QS power module	LQSE-2ECO-D
myRoom Plus power module	

eldoLED DRIVER COMPATIBILITY

Power supply UEG / UEN Dimmer / Switch Control Manufacturer	Family/Model #
Busch-Jaeger	2112U-101
Jung	240-10
Leviton Lighting Controls	IP710-DLX
Lightolier Controls	ZP600FAM120
Lutron Electronics	Nova T® - NTFTV
Lutron Electronics	Divva® - DVTV
Lutron Electronics	Nova® - NFTV
Merten	5729
Pass & Seymour	CD4FB-W
The Watt Stopper	DCLV1
Sensor Switch	nIO EZ
Synergy	ISD BC
Power supply UEG / UEN Lighting Control Systems Manufacturer	Family/Model #
Lutron Electronics	GrafixEye® GRX-TVI w GRX3503
Lutron Electronics	Energy Savr Node™ - QSN-4T16-S
Lutron Electronics	TVM2 Module
Crestron®	GLX-DIMFLV8
Crestron®	GLXP-DIMFLV8
Crestron®	GLPAC-DIMFLV4-*
Crestron®	GLPAC-DIMFLV8-*
Crestron®	GLPP-DIMFLVEX-PM
Crestron®	GLPP-1DIMFLV2EX-PM
Crestron®	GLPP-1DIMFLV3EX-PM
Crestron®	DIN-A08
Crestron®	DIN-4DIMFLV4
Crestron®	CLS-EXP-DIMFLV
Crestron®	CLCI-1DIMFLV2EX
ABB	SD/S 2.16.1

ANALOG DRIVERS AND DIMMERS

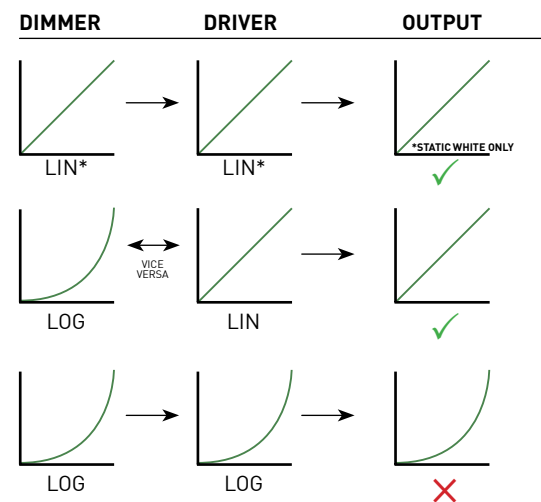

LIN = LINEAR
 LOG = LOGARITHMIC
 *LIN-TO-LIN NOT COMPATIBLE FOR WARM DIM

