

# CYLINDER 2 SURFACE MOUNT

Our best-selling cylinders keep getting better. Adjustable, fixed, and wallwash are all offered in a broad range of sizes, with lumens from 500 to almost 5000lm, standard 90° tilt, and more than a dozen finish options. Now, there's a fixture for anywhere you need to illuminate anything.

PROJECT NAME:	TYPE:
---------------	-------



## ORDERING INFORMATION



Quick Ship Product. All rough in components ship within 10 days up to quantities of 100.



JA8-2022 COMPLIANCE INDICATED BY SHADING

CYLINDER	FUNCTION	RATING	CYLINDER FINISH	BAFFLE FINISH	CRI / WATTAGE PACKAGE	CCT	OPTIC (UGR)	MEDIA	POWER SUPPLY	MOUNTING	
<b>CY2X</b>											
CY2X 3.125" Ø	AD 90° Adjustable	1 Dry / Damp (IP30)	POWDERCOAT FINISHES	POWDERCOAT FINISHES	STATIC WHITE	24 2400K* *90+CRI only	10 10° (<13)	STANDARD MEDIA	INTEGRAL	ROUGH-IN	
											80S11B 80+ CRI, 11 Watts Lm. Delivered - 1111
	AS Shallow Canopy* *(Remote driver only)	2 Wet (IP65)	WH White	WH White	80S17B 80+ CRI, 17 Watts Lm. Delivered - 1613	30 3000K	20 20° (<10)	0 No Lens* *(Recommended for 10° optic, not available for Warm Dim or Wet Location)	1CE 120V Electronic Forward/Reverse	REMOTE (120V)	FINISH OUT
	AW Adj. Wallwash		AG Satin Silver	AG Satin Silver	90S11B 90+ CRI, 11 Watts Lm. Delivered - 950	40 4000K	40 40° (<10)	60 60° (<16)	ALTERNATE MEDIA	1L2 Lutron Hi-Lume 1%, 2-Wire	1RE Forward/Reverse
	FB Fixed		AU Cashmere Gold	AU Cashmere Gold	90S23B 90+ CRI, 23 Watts Lm. Delivered - 1960					3 Clear Glass Lens (CGL)* *(Not available for Warm Dim or Wet Location)	3SMK3 3/0 Surface Mount Kit*
	WW Wallwash Fixed		AB Architectural Bronze	AB Architectural Bronze	97S17B 97+ CRI, 17 Watts Lm. Delivered - 1357					6 Frosted Soft Focus Lens (FSFL)	UEG eldoLED, SOLOdrive 0.1% 0-10V, LOG
			BB Burnt Bronze	BB Burnt Bronze	90W23B 90+ CRI, 23 Watts Incandescent Profile Lm. Delivered - 1469					C Clear Glass Film w/ Honeycomb Louver	UED eldoLED, SOLOdrive 0.1% DALI-2, LOG
			BK Black	BK Black	Halogen Profile Lm. Delivered - 1698					S Soft Focus Film w/ Honeycomb Louver	UAD/ Athena Control, UADR EldoLED, DUALdrive*
			CF Custom Finish* *(Consult Factory)	CF Custom Finish* *(Consult Factory)	*SEE PAGE 3 FOR DETAILED PERFORMANCE CONFIGURATIONS AND WARM DIM PROFILE COMPARISON.						UCR EldoLED, SOLOdrive 0.1% 120-277V* *(Includes Node. Extended lead time, consult factory. UAR/UCR includes shunt.)
			ALUMINA FINISHES	ALUMINA FINISHES	TUNABLE WHITE (REMOTE DRIVER ONLY)						TUNABLEWHITE REMOTE (0.1%, 120-277V)
			02 Matte Obsidian	02 Matte Obsidian	Cool Profile Lm. Delivered - 2277						UDG eldoLED, DUALdrive 0-10V, LOG
		04 Matte Dark Patinated Bronze	04 Matte Dark Patinated Bronze							UAD1/ Athena Control, UADR EldoLED, DUALdrive*	
											05 Brushed Aged Aluminum
		06 Matte Aged Aluminum	06 Matte Aged Aluminum							UCDR EldoLED, DUALdrive*	
											07 Brushed Cast Brass
		08 Matte Cast Brass	08 Matte Cast Brass								
											09 Brushed Light Patinated Bronze
		10 Matte Light Patinated Bronze	10 Matte Light Patinated Bronze								
											FINISH IMAGES ON PAGE 2

### PART NUMBER NOTES

- CY2X ships as e.g., CY2XAD1WHWH80S17A304041CE3
- Remote driver ships as e.g., PS-RMT-80S17A-1RE3
- Mounting part numbers listed on page 6



Declare.

# CYLINDER 2 SURFACE MOUNT

## ACCESSORIES

### REPLACEMENT MEDIA

Dry / Damp location only, consult factory for wet location replacements

- SFL-CY2X-03** Soft Focus Lens
- HCL-CY2X-03** Honeycomb Louver \*

\*(Not available for Warm Dim)

- CGL-CY2X-03** Clear Glass Lens \*

\*(Not available for Warm Dim)

- FGL-CY2X-03** Frosted Glass Lens
- FSFL-CY2X-03** Frosted Soft Focus Lens
- FLSL-CY2X-03** Frosted Linear Spread Lens
- CGL-HCL-CY2X-03** Clear Glass Film W/ Honeycomb Louver
- SFL-HCL-CY2X-03** Soft Focus Film W/ Honeycomb Louver

### STATIC WHITE REPLACEMENT OPTICS

- RO-70-15-S** 15° optic
- RO-70-20-S** 20° optic
- RO-70-25-S** 25° optic
- RO-70-40-S** 40° optic
- RO-70-60-S** 60° optic

### WARM DIM REPLACEMENT OPTICS

- RO-70-20-W** 20° optic
- RO-70-25-W** 25° optic
- RO-70-40-W** 40° optic
- RO-70-60-W** 60° optic

### TUNABLE WHITE REPLACEMENT OPTICS

- RO-70-15-T** 15° optic
- RO-70-20-T** 20° optic
- RO-70-25-T** 25° optic
- RO-70-40-T** 40° optic
- RO-70-60-T** 60° optic

### EMERGENCY LIGHTING - REMOTE MOUNT ONLY

During disruption of main power, emergency battery inverter provides temporary 120V or 277V to fixture.

- EMB-S-25-120/277-LEDX** 25 watt max capacity, 120 or 277 VAC 60Hz
- EMB-S-100-120-LEDX** 100 watt max capacity, 120 VAC 60Hz, 0-10V dimmable
- EMB-S-100-277-LEDX** 100 watt max capacity, 277 VAC 60Hz, 0-10V dimmable
- EMB-S-250-120/277-LEDX** 250 watt max capacity, 120 or 277 VAC 60Hz

**\*SHUNT REQUIRED FOR USE WITH ATHENA AND CASAMBI CONTROLS, CONSULT FACTORY FOR DETAILS.**

## POWDERCOAT FINISHES



## ALUMINA FINISHES BY LUCIFER LIGHTING™



# CYLINDER 2 SURFACE MOUNT

## WALLWASH DESIGN GUIDE



### 10° TILT

#### 30" SETBACK / 30" ON CENTER SPACING

- 10FT CEILING SHOWN / 8-12FT IDEAL
- AVERAGE FC: 33.74
- MAX / MIN: 4.89
- 9 FIXTURES / 25FT WALL SHOWN



### RECOMMENDED

### 15° TILT

#### 36" SETBACK / 36" ON CENTER SPACING

- 10FT CEILING SHOWN / 8-12FT IDEAL
- AVERAGE FC: 30.07
- MAX / MIN: 4.35
- 9 FIXTURES / 25FT WALL SHOWN

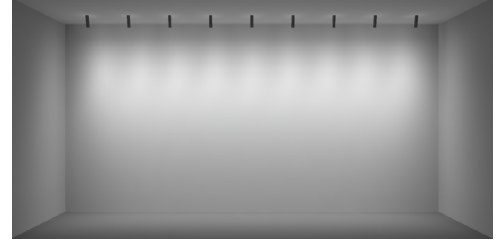

### 20° TILT

#### 42" SETBACK / 42" ON CENTER SPACING

- 10FT CEILING SHOWN / 8-12FT IDEAL
- AVERAGE FC: 27.25
- MAX / MIN: 4.07
- 9 FIXTURES / 25FT WALL SHOWN

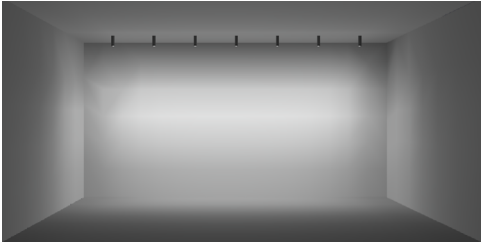

#### 30" SETBACK / 42" ON CENTER SPACING

- 10FT CEILING SHOWN / 8-12FT IDEAL
- AVERAGE FC: 25.44
- MAX / MIN: 6.25
- 9 FIXTURES / 25FT WALL SHOWN

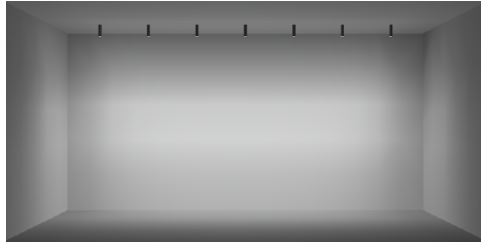

### RECOMMENDED

#### 36" SETBACK / 48" ON CENTER SPACING

- 10FT CEILING SHOWN / 8-12FT IDEAL
- AVERAGE FC: 20.44
- MAX / MIN: 6.06
- 9 FIXTURES / 30FT WALL SHOWN

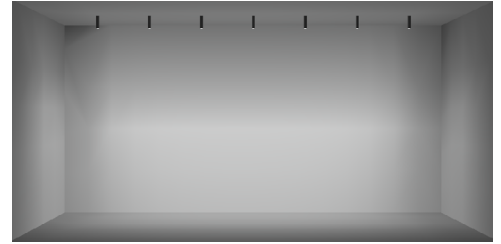

#### 42" SETBACK / 54" ON CENTER SPACING

- 10FT CEILING SHOWN / 8-12FT IDEAL
- AVERAGE FC: 16.48
- MAX / MIN: 6.24
- 9 FIXTURES / 35FT WALL SHOWN

## ADDITIONAL SETBACKS AND SPACINGS

ON CENTER SPACING	SETBACK / TILT			ON CENTER SPACING	SETBACK		
	30" / 10°	36" / 15°	42" / 20°		30"	36"	42"
30"	SHOWN ABOVE	AVERAGE FC: 35.46 MAX / MIN: 4.37	AVERAGE FC: 36.51 MAX / MIN: 4.12	42"	SHOWN ABOVE	AVERAGE FC: 22.85 MAX / MIN: 6.30	AVERAGE FC: 20.41 MAX / MIN: 6.41
36"	AVERAGE FC: 28.80 MAX / MIN: 4.98	SHOWN ABOVE	AVERAGE FC: 31.27 MAX / MIN: 4.04	48"	AVERAGE FC: 22.75 MAX / MIN: 6.02	SHOWN ABOVE	AVERAGE FC: 18.24 MAX / MIN: 6.19
42"	AVERAGE FC: 25.13 MAX / MIN: 5.20	AVERAGE FC: 26.20 MAX / MIN: 4.42	SHOWN ABOVE	54"	AVERAGE FC: 20.53 MAX / MIN: 6.11	AVERAGE FC: 18.44 MAX / MIN: 6.09	SHOWN ABOVE

**\*ALL DATA REFLECTS 90S17A WATTAGE PACKAGE**

# CYLINDER 2 SURFACE MOUNT

## STATIC WHITE PERFORMANCE - 3000K

LUMEN PACKAGE	WATTAGE	10° OPTIC NO LENS		15° OPTIC SOFT FOCUS LENS		20° OPTIC SOFT FOCUS LENS		25° OPTIC SOFT FOCUS LENS		40° OPTIC SOFT FOCUS LENS		60° OPTIC SOFT FOCUS LENS		WALLWASH WALLWASH LENS		ADJ. WALLWASH WALLWASH LENS	
		DLVD	LPW	DLVD	LPW	DLVD	LPW	DLVD	LPW	DLVD	LPW	DLVD	LPW	DLVD	LPW	DLVD	LPW
80S11B	11	-	-	1095	99	1151	104	1151	104	1073	97	1018	92	706	64	917	83
80S17B	17	1447	85	1651	97	1768	103	1789	105	1654	97	1583	93	1094	64	1416	83
80S23B	23	-	-	2201	95	2360	102	2374	103	2201	95	2112	91	1452	63	1884	81
90S11B	11	-	-	936	85	984	89	984	89	917	83	870	79	603	54	784	71
90S17B	17	1237	72	1411	83	1511	88	1529	89	1414	83	1353	79	935	55	1210	71
90S23B	23	-	-	1881	81	2017	87	2029	88	1882	81	1805	78	1241	53	1610	70
97S11B	11	-	-	861	78	905	82	905	82	844	76	800	72	555	50	721	65
97S17B	17	1138	66	1298	76	1390	81	1407	82	1301	76	1245	73	860	50	1113	65
97S23B	23	-	-	1731	75	1856	80	1867	81	1731	75	1661	72	1442	49	1481	64
90W23BL (2700K-1800K)	23	-	-	-	-	1530	66	1516	65	1425	61	1344	58	1137	49	1238	53
90W23BD (3000K-1800K)	23	-	-	-	-	1592	69	1582	68	1495	65	1419	61	1267	55	1305	56
90T32BTR (4000K-1800K)	32	-	-	2360	73	2472	77	2468	77	2326	72	2224	69	1669	52	2035	63
90T32BTH (5000K-2700K)	32	-	-	2254	70	2351	72	2334	71	2208	67	2105	59	1848	57	1910	59

### MEDIA LIGHT LOSS FACTOR

MEDIA	LIGHT LOSS FACTOR
No Lens	1.07
CGL	0.98
SFL	1.00
FGL	0.94
FSFL	0.93
FLSL	0.85
HCL	0.72
SFL+HCL	0.66

### OUTPUT MULTIPLIER

CCT	CCT SCALE
2400K	0.76
2700K	0.957
3000K	1.000
3500K	1.019
4000K	1.030

### TUNABLE WHITE MULTIPLIER

CCT	5000K-2700K	4000K-1800K
5000K	1.16	-
4000K	1.08	1.14
3500K	1.04	1.07
3000K	1.00	1.00
2700K	0.96	0.92
2400K	-	0.84
1800K	-	0.69



JA8-2022 INDICATED BY SHADING

### UNIFIED GLARE RATING

10° OPTIC NO LENS	15° OPTIC SOFT FOCUS LENS	20° OPTIC SOFT FOCUS LENS	25° OPTIC SOFT FOCUS LENS	40° OPTIC SOFT FOCUS LENS	60° OPTIC SOFT FOCUS LENS	WALLWASH WALLWASH LENS
<13	<13	<10	<10	<10	<16	>19

## WARM DIM PERFORMANCE - SOFT FOCUS LENS - 20° OPTIC

### INCANDESCENT DIMMING PROFILE

90W23BL 2700K - 1800K	Full on 100%	Dimmed to 80%	Dimmed to 70%	Dimmed to 50%	Dimmed to 20%	Dimmed to 10%	Dimmed to 2%
CCT (K)	2700	2650	2620	2520	2180	1950	1800
Light Output (Lm)	1530	1224	1071	765	306	153	31
Power (W)	23	18	16	12	5	2.3	0.5
Efficacy (LPW)	66	66	66	66	66	66	66

### HALOGEN DIMMING PROFILE

90W23BD 3000K - 1800K	Full on 100%	Dimmed to 80%	Dimmed to 70%	Dimmed to 50%	Dimmed to 20%	Dimmed to 10%	Dimmed to 2%
CCT (K)	3000	2950	2920	2775	2375	2000	1800
Light Output (Lm)	1592	1274	1114	796	318	159	32
Power (W)	23	18	16	12	5	2.3	0.5
Efficacy (LPW)	69	69	69	69	69	69	69

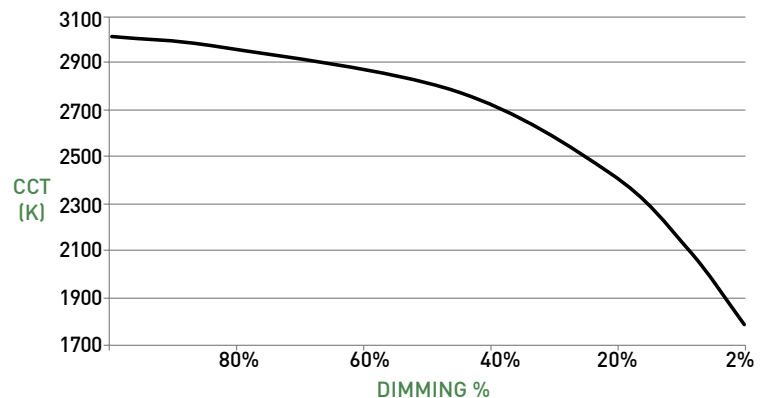
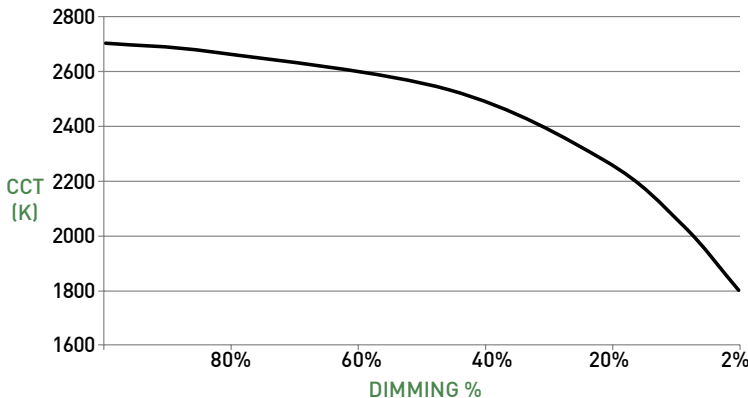

# CYLINDER 2 SURFACE MOUNT

## CYLINDER ASSEMBLY

- A ADJUSTABLE - STANDARD CANOPY**  
Die-cast canopy accommodates flat and sloped ceiling conditions. Conceals hidden mounting hardware. "AD" (90° tilt, 365° rotation) canopy features 1.9" (48mm) tall canopy. Available with integral or remote driver.
- B ADJUSTABLE - SHALLOW CANOPY**  
Die-cast canopy accommodates flat and slope ceiling conditions. Conceals hidden mounting hardware. "AS" (90° tilt, 365° rotation) canopy features 0.65" (17mm) tall canopy, reducing overall height. Requires remote power supply
- C FIXED BODY**  
Body with integrated heat sink and LED. Conceals mounting hardware. Power supply may be integral or remote mount.
- D WALLWASH FIXED BODY**
- E OPTICS**  
Robust light engine with optimized optic pairing integrates Reflection, Refraction, and TIR offering 10°, 15°, 20°, 25°, 40° & 60° beams.
- F MEDIA**  
Cylinder accepts 2 lenses; soft focus lens, no lens or wallwash lens standard. Sealed in place for Wet locations.
- G BAFFLE**  
Die-cast baffle minimizes aperture glare and conceals view into fixture.
- H WALL-MOUNT**  
Cylinder may be wall mounted using any mounting option.

## DIMENSIONS / DRAWINGS

### A ADJUSTABLE BODY STANDARD CANOPY

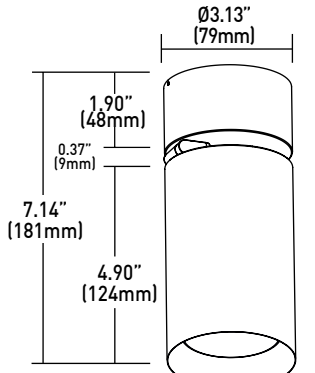

Cylinder weight  
2.10 lbs

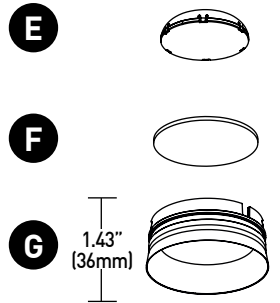

### B ADJUSTABLE BODY SHALLOW CANOPY

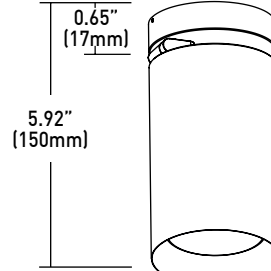

Cylinder weight  
1.95 lbs

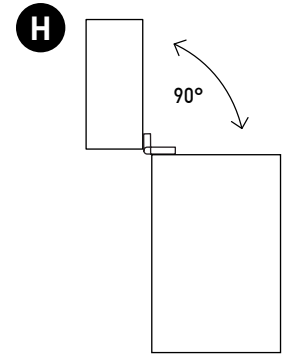
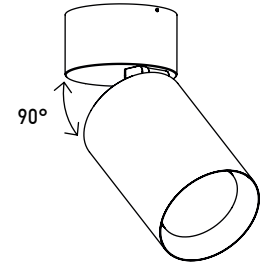
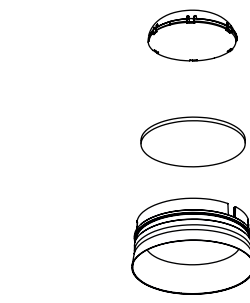

### C FIXED BODY

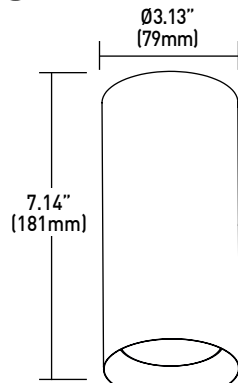

Cylinder weight  
2.80 lbs

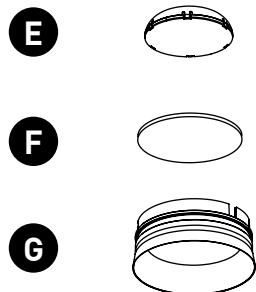

### D WALLWASH FIXED BODY



Cylinder weight  
3.00 lbs



# CYLINDER 2 SURFACE MOUNT

## MOUNTING

- I JBMP**  
Mounting plate (concealed) for standard 4" square or 4" 4/0 j-box. To be installed during rough-in prior to substrate. Fixture to mount flush with minimalist transition to ceiling.  
Part Number - CY2X-JBMP
- J SMK3**  
Surface mount kit includes mounting plate and 4" concealer plate that installs between fixture and standard 3" 3/0 j-box for existing applications where standard j-box cutout is to be concealed.  
Part Number - CY2X-SMK-3/0-(FINISH)
- K SMK4**  
Surface mount kit includes mounting plate and 5" concealer plate that installs between fixture and standard 4" 4/0 j-box for existing applications where standard j-box cutout is to be concealed.  
Part Number - CY2X-SMK-4/0-(FINISH)
- L CMJB**  
Ceiling mount junction box perfectly matches the cylinder profile for a continuous, integrated look where exposed ceiling mount junction box and conduit applications apply. For use with 1/2" and 3/4" EMT conduit only. Features two conduit entrances on either side and one conduit knockout on top of j-box. J-box is IP10 rated; painted finishes only. Blank off plugs included.  
Part Number - CY2X-CMJB-(FINISH)

## DIMENSIONS / DRAWINGS

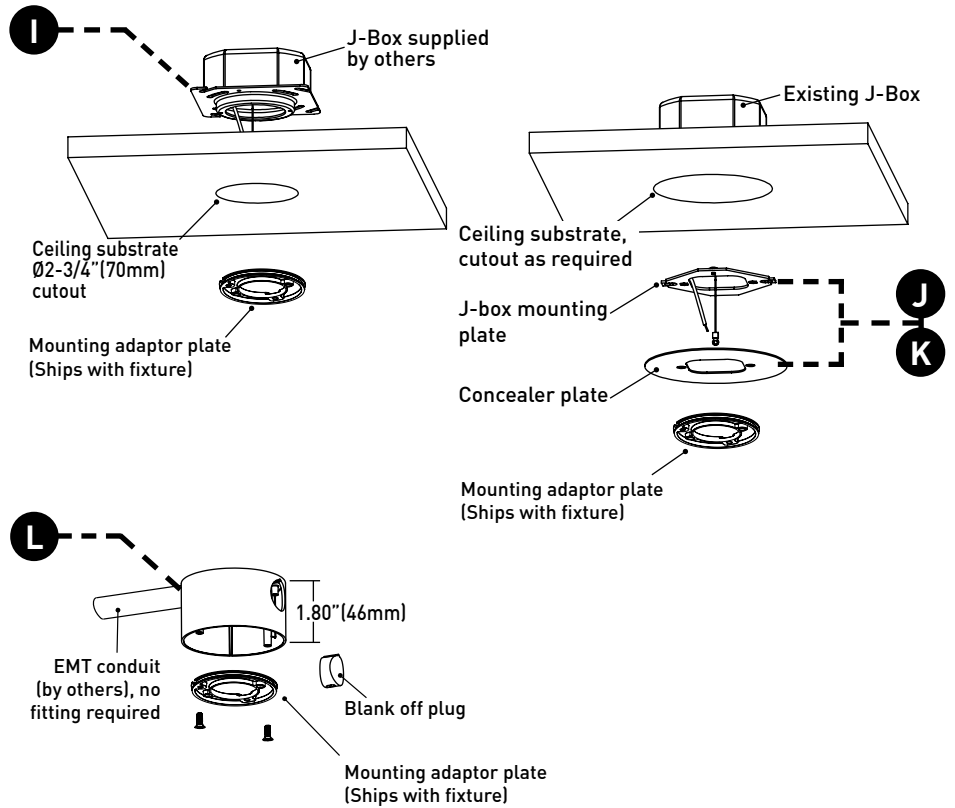

## MOUNTING NOTES

- CY2X-JBMP and CY2X-SMK-3/0 & 4/0 not recommended for use with pancake style j-box.

## REMOTE POWER SUPPLY

- M PS-RMT**  
Remote power supply must be mounted in accessible area. Mounting device still required. Consult page 8 for dimming compatibility list. Consult install guide for complete details of suitable controls, wiring diagrams, and maximum allowable secondary run lengths between PS-RMT and cylinder.  
PS-RMT weight - 1.40 lbs
- N ATHENA / CASAMBI CONTROL**  
Controls integrated into remote driver assembly. All equipment is serviceable.  
Athena Model Number: A-WN-D01-RF-BL & DC-OEM-DBI  
Casambi Model Number: BT-S1E1-5400
- O ATHENA / CASAMBI EM SHUNT**  
Included with drivers specified as ASR, ADR, CSR, or CDR. One required for each wireless EM fixture, requires class 2 control wiring between fixture and shunt. Features integrated test switch.  
Model Number: PS-RMT-SHUNT

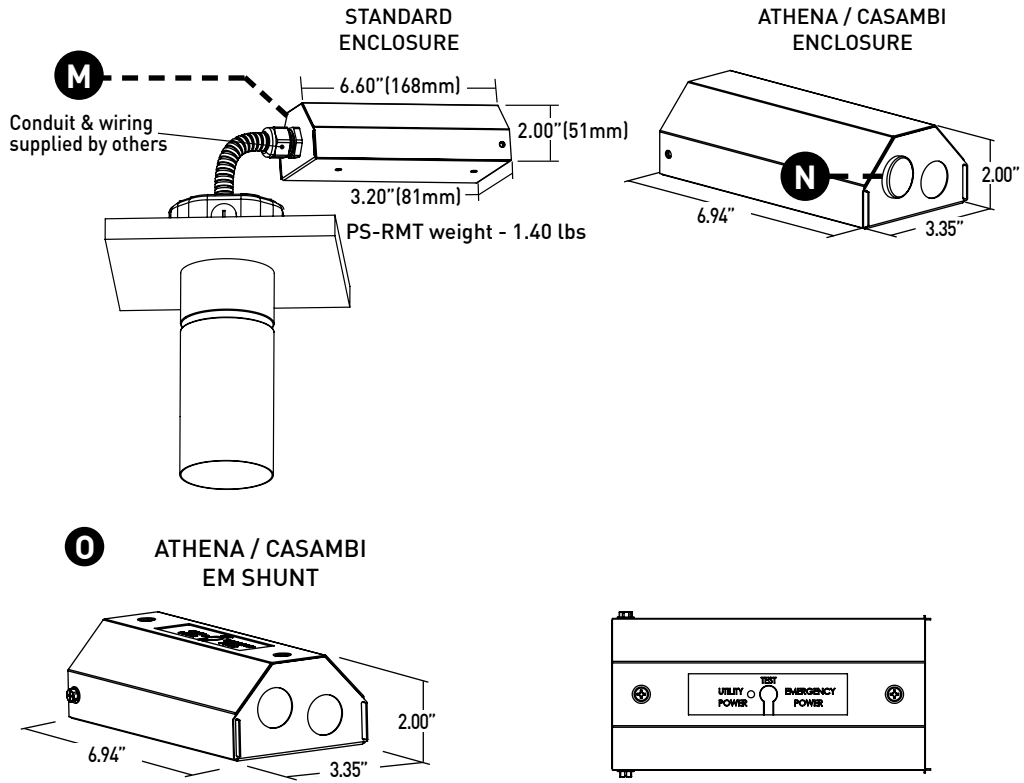

# CYLINDER 2 SURFACE MOUNT

## TECHNICAL

### CONSTRUCTION

**Cylinder:** Die-cast aluminum body with integrated heat sink; painted finishes are granulated powder coat. Alumina finishes are anodized aluminum.

**CMJB:** Die-cast aluminum body; painted finishes are granulated powder coat.

**Remote Power Supply:** 22 Gauge galvanized steel.

### STATIC WHITE LED

2-step MacAdam ellipse LED module available in 80+, 90+ and 97+ CRI configurations in color temperatures of 2700K, 3000K, 3500K and 4000K.

3-step MacAdam ellipse LED module available in 90+ CRI configuration in color temperature of 2400K. Average rated lamp life of 50,000 hours. LED and driver assemblies are field-replaceable.

### WARM DIM LED

3-step MacAdam ellipse warm dim LED module available in 90+ CRI configuration. 3000K or 2700K at full brightness, warming to 1800K at full dim. Average rated lamp life of 50,000 hours. LED and driver assemblies are field-replaceable.

### TUNABLE WHITE LED

3-Step MacAdam ellipse tunable white LED module available in 90+ CRI configuration. Features tuning range of 2700K to 5000K and 1800K to 4000K. Average rated lamp life of 50,000 hours. Driver assemblies are field-replaceable.

### POWER SUPPLY PERFORMANCE AND DIMMING INFORMATION

Power Supply	PHASE			0-10V							ECO	DALI			ATHENA	CASAMBI
	1CE/1RE	1TR	1L2	UCA/URA	UAN	ULN	UEG	UEN	UDG	UDN	ULH	UED	ULD	UDD	UAS/UAD	UCS/UCD
Minimum °C	-20 °C	-20 °C	0 °C	-20 °C	-20 °C	-20 °C	-20 °C	-20 °C	-20 °C	-20 °C	0 °C	-20 °C	-20 °C	-20 °C	0 °C	-20 °C
Maximum °C	40 °C	40 °C	40 °C	40 °C	40 °C	40 °C	40 °C	40 °C	40 °C	40 °C	40 °C	40 °C	40 °C	40 °C	40 °C	40 °C
Dimming %	1.0%	2.0%	1.0%	1.0%	1.0%	1.0%	0.1%	0.1%	0.1%	0.1%	1.0%	0.1%	0.1%	0.1%	0.1%	0.1%

Note: For 1TR, 1L2, ULH, UAN, ULN, UEG and UEN drivers consult chart on page 8 to confirm appropriate dimming curve for compatibility with selected control.

### MAXIMUM ALLOWABLE REMOTE DRIVER WIRING DISTANCES

DRIVER	WIRE AWG				
	12	14	16	18	20
URA, 1RE	-	164'	105'	66'	40'
1TR, UAN, ULN	285'	180'	113'	71'	45'
1L2, ULH	60'	40'	25'	15'	-
UEG, UEN, UED, ULD, DD1, DG1, DN1, UAS, UCS, UAD, UCD	-	-	118'	72'	46'

### WALLWASH SPACING AND TILT

Adjustable Wallwash Cylinder must be tilted to achieve wallwashing effect. Recommended adjustable spacing is 36" (914mm) on center with 36" (914mm) setback from wall plane with 15° tilt. Recommended fixed spacing is 36" (914mm) on center spacing with 48" (1219mm) setback from wall plane.

### MOUNTING

Cylinder is supplied with a mounting adaptor plate, which integrates with required additional mounting accessories specified separately according to field application conditions, providing a minimalist transition from standard 4/0 or 4" square junction boxes and accommodating ceiling thicknesses of 0.44" (12mm) to 0.75" (19mm). Ceiling-mount junction box available for 1/2" (13mm) and 3/4" (19mm) conduit and feature concealed internal clamps for clean fitting-free conduit exit and entry.

### LISTING

cTUVus listed to UL1598 standard for Dry / Damp (IP30) and Wet (IP65) location. Title 24 JA8-2022 Listed. NEMA 410 Compliant. Buy American Act compliant.

### DECLARE

LBC Red List Approved

### WARRANTY

Manufacturer's 1-year warranty guarantees product(s) listed to be free from defects in material and workmanship under normal use and service. 5-year warranty on LED and power supply to operate with 70% of the original flux and remain within a range of 3 duv. 10-year Lutron Advantage limited warranty available on Lutron equipped systems. Warranty period begins from the date of shipment by Seller. Consult [website](#) for full warranty terms and conditions.



# CYLINDER 2 SURFACE MOUNT

## DIMMING COMPATIBILITY

### PHILIPS DRIVER COMPATIBILITY

Power supply 1TR Manufacturer	Family/Model #
Lutron Electronics	DV-600P
Lutron Electronics	DVELV-303P
Lutron Electronics	NTELV-600
Lutron Electronics	MAELV-600
Lutron Electronics	SELV-300P
Lutron Electronics	DVLV-600P
Lutron Electronics	NFTU-5A
Lutron Electronics	CTCL-153P
Lutron Electronics	GL-600H
Lutron Electronics	S-600P
Lutron Electronics	PHPM
Power supply UAN / ULN Manufacturer	Family/Model #
Lutron Electronics	DVTV plus PP-DV
Lutron Electronics	DVSCTV plus PP-DV
Lutron Electronics	DVSTV
Lutron Electronics	DVSCSTV
Lutron Electronics	QSGRJ-XP plus GRX-TVI
Lutron Electronics	QSGRJ-XE plus GRX-TVI
Lutron Electronics	QSGR-XE plus GRX-TVI
Lutron Electronics	NFTV plus PP-DV
Lutron Electronics	NTSTV
Lutron Electronics	RMJ-5T
Lutron Electronics	RMJS-8T
Lutron Electronics	FCJS-010
Leviton	IlumaTch IP7 series
Philips	Sunrise - SR1200ZTUNV

### LUTRON DRIVER COMPATIBILITY

Power supply 1L2 Lutron Product Family	Part No.
Maestro WirelessR 600 W dimmer	MRF2-6ND-120-
Maestro WirelessR 1000 W dimmer	MRF2-10ND-120-
Caséta® Wireless Pro 1000 W dimmer	PD-10NXD-
GRAFIK T™ CL® dimmer	GT-250M- GTJ-250M-
HomeWorks® QS adaptive dimmer	HQRD-6NA-
HomeWorks® QS 600 W dimmer	HQRD-6ND-
HomeWorks® QS 1000 W dimmer	HQRD-10ND-
RadioRA® 2 adaptive dimmer	RRD-6NA-
RadioRA® 2 1000 W dimmer	RRD-10ND
myRoom™ DIN power module	MQSE-4A1-D
HomeWorks® QS DIN power module	LQSE-4A1-D
HomeWorks® QS wallbox power module	HQRJ-WPM-6D-120
HomeWorks® wallbox power module	HWI-WPM-6D-120
GRAFIK Eye® QS control unit	QSGR-, QSGRJ-
GRAFIK Eye® 3000 control unit	GRX-3100- GRX-3500-
RPM-4U module (LCP, HomeWorks® QS, GRAFIK Systems™, Quantum®)	HW-RPM-4U-120 LP-RPM-4U-120
RPM-4A module (LCP, HomeWorks® QS, GRAFIK Systems™, Quantum®)	HW-RPM-4A-120, LP-RPM-4A-120
GP dimming panels	Various
Ariadni CL 250W dimmer	AYCL-253P-
Diva CL 250W dimmer	DVCL-253P- DCSCCL-253P-
Nova T CL 250W dimmer	NTCL-250-
Power supply ULH Lutron Product Family	Part No.
PowPak Dimming Modules	RMJ-ECO32-DV-B
PowPak Dimming Modules	FCJ/FCJS-ECO
Energi Savr Nodes	QSN-1ECO-S
GRAFIK Eye QS control unit	QSN-2ECO-S
Homeworks QS control unit	QSGRJ- _E (wireless) QSGR- _E
Quantum Hub	QP2-__ 2C
Quantum Hub	QP2-__ 4C
Quantum Hub	QP2-__ 6C
Quantum Hub	QP2-__ 8C
Homeworks QS power module	LQSE-2ECO-D
myRoom Plus power module	

### eldoLED DRIVER COMPATIBILITY

Power supply UEG / UEN Dimmer / Switch Control Manufacturer	Family/Model #
Busch-Jaeger	2112U-101
Jung	240-10
Leviton Lighting Controls	IP710-DLX
Lightolier Controls	ZP600FAM120
Lutron Electronics	Nova T® - NTFTV
Lutron Electronics	Divva® - DVTV
Lutron Electronics	Nova® - NFTV
Merten	5729
Pass & Seymour	CD4FB-W
The Watt Stopper	DCLV1
Sensor Switch	nIO EZ
Synergy	ISD BC
Power supply UEG / UEN Lighting Control Systems Manufacturer	Family/Model #
Lutron Electronics	GrafixEye® GRX-TVI w GRX3503
Lutron Electronics	Energy Savr Node™ - QSN-4T16-S
Lutron Electronics	TVM2 Module
Crestron®	GLX-DIMFLV8
Crestron®	GLXP-DIMFLV8
Crestron®	GLPAC-DIMFLV4-*
Crestron®	GLPAC-DIMFLV8-*
Crestron®	GLPP-DIMFLVEX-PM
Crestron®	GLPP-1DIMFLV2EX-PM
Crestron®	GLPP-1DIMFLV3EX-PM
Crestron®	DIN-A08
Crestron®	DIN-4DIMFLV4
Crestron®	CLS-EXP-DIMFLV
Crestron®	CLCI-1DIMFLV2EX
ABB	SD/S 2.16.1

## ANALOG DRIVERS AND DIMMERS

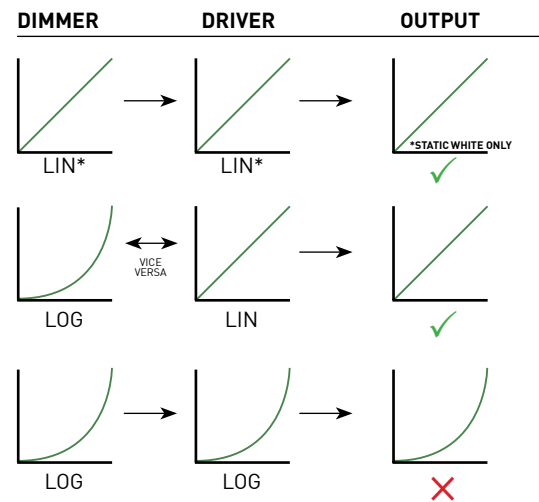

LIN = LINEAR  
 LOG = LOGARITHMIC  
 \*LIN-TO-LIN NOT COMPATIBLE FOR WARM DIM

