

CYLINDER 1 SURFACE MOUNT

Our best-selling cylinders keep getting better. Adjustable, fixed, and wallwash are all offered in a broad range of sizes, with lumens from 500 to almost 5000lm, standard 90° tilt, and more than a dozen finish options. Now, there's a fixture for anywhere you need to illuminate anything.

PROJECT NAME:	TYPE:
---------------	-------

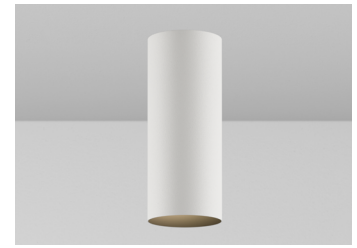
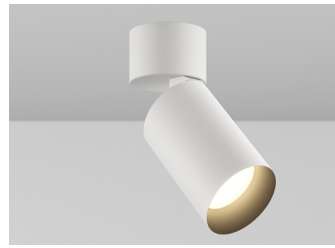

ORDERING INFORMATION



Quick Ship Product. All rough in components ship within 10 days up to quantities of 100.



JA8-2022 COMPLIANCE INDICATED BY SHADING

CYLINDER	FUNCTION	RATING	CYLINDER FINISH	BAFFLE FINISH	CRI / WATTAGE PACKAGE	CCT	OPTIC (UGR)	MEDIA	POWER SUPPLY	MOUNTING
CY1X										
CY1X 2.5" Ø	AD 90° Adjustable	1 Dry / Damp (IP30) 2 Wet (IP65)	POWDERCOAT FINISHES WH White AG Satin Silver AU Cashmere Gold AB Architectural Bronze BB Burnt Bronze BK Black CF Custom Finish* *(Consult Factory) ALUMINA FINISHES 01 Brushed Obsidian 02 Matte Obsidian 03 Brushed Dark Patinated Bronze 04 Matte Dark Patinated Bronze 05 Brushed Aged Aluminum 06 Matte Aged Aluminum 07 Brushed Cast Brass 08 Matte Cast Brass 09 Brushed Light Patinated Bronze 10 Matte Light Patinated Bronze FINISH IMAGES ON PAGE 2	POWDERCOAT FINISHES WH White AG Satin Silver AU Cashmere Gold AB Architectural Bronze BB Burnt Bronze BK Black CF Custom Finish* *(Consult Factory) ALUMINA FINISHES 01 Brushed Obsidian 02 Matte Obsidian 03 Brushed Dark Patinated Bronze 04 Matte Dark Patinated Bronze 05 Brushed Aged Aluminum 06 Matte Aged Aluminum 07 Brushed Cast Brass 08 Matte Cast Brass 09 Brushed Light Patinated Bronze 10 Matte Light Patinated Bronze FINISH IMAGES ON PAGE 2	STATIC WHITE 80S11A 80+ CRI, 11 Watts Lm. Delivered - 1104 80S17A 80+ CRI, 17 Watts Lm. Delivered - 1643 90S11A 90+ CRI, 11 Watts Lm. Delivered - 952 90S17A 90+ CRI, 17 Watts Lm. Delivered - 1416 97S11A 97+ CRI, 11 Watts Lm. Delivered - 838 97S17A 97+ CRI, 17 Watts Lm. Delivered - 1246 WARM DIM 90W18A 90+ CRI, 18 Watts Incandescent Profile Lm. Delivered - 1216 Halogen Profile Lm. Delivered - 1202 *SEE PAGE 3 FOR DETAILED PERFORMANCE CONFIGURATIONS AND WARM DIM PROFILE COMPARISON. TUNABLE WHITE (REMOTE DRIVER ONLY) 90T17A 90+ CRI, 17 Watts Warm Profile Lm. Delivered - 1291 Cool Profile Lm. Delivered - 1251 *ALL DELIVERED LUMEN OUTPUTS AND T24 COMPLIANCE REFLECT 3000K PAIRED WITH 60° OPTIC AND SOFT FOCUS LENS.	24 2400K* *90+ CRI only 27 2700K 30 3000K 35 3500K 40 4000K WL 2700K - 1800K WD 3000K - 1800K TR 4000K - 1800K TH 5000K - 2700K	10 10° (<16) *117 Watts only 15 15° (<16) 20 20° (<10) 25 25° (<10) 30 30° (<10) 40 40° (<10) 60 60° (<16) WW Wallwash* *(Required for WW & AW fixture)	STANDARD MEDIA 4 Soft Focus Lens (SFL) 0 No Lens* *(Recommended for 10° optic, not available for Warm Dim or Wet Location) ALTERNATE MEDIA 2 Honey Comb Louver (HCL)* *(Not available for Warm Dim or Wet Location) 3 Clear Glass Lens (CGL)* *(Not available for Warm Dim or Wet Location) 5 Frosted Glass Lens (FGL) 6 Frosted Soft Focus Lens (FSFL) 7 Frosted Linear Spread Lens (FSL) C Clear Glass Lens w/ Linear Spread Lens H Soft Focus Lens w/ Honey Comb Louver W Wallwash Lens* *(Required for WW and AW fixture)	INTEGRAL UCA 0-10V Analog 120-277V 1CE 120V Electronic Forward/Reverse REMOTE (120V) 1TR Philips, 2% Forward/Reverse 1L2 Lutron Hi-Lume 1%, 2-Wire 1RE Forward/Reverse REMOTE (120-277V) URA 0-10V Analog ULH Lutron Hi-Lume Ecosystem 1% Fade to Black UAN Philips Xitanium 1% 0-10V, LOG ULN Philips Xitanium 1% 0-10V, LIN UEG eldoLED, SOLdrive 0.1% 0-10V, LOG UEN eldoLED, SOLdrive 0.1% 0-10V, LIN UED eldoLED, SOLdrive 0.1% DALI-2, LOG ULD eldoLED, SOLdrive 0.1% DALI-2, LIN UAS/ Athena Control UAR EldoLED, SOLdrive 0.1% 120-277V* UCS/ Casambi Control UCR EldoLED, SOLdrive 0.1% 120-277V* *(Includes Node. Extended lead time, consult factory for EM use) TUNABLE WHITE REMOTE (0.1%, 120-277V) UDD eldoLED, DUALdrive DALI-2, LOG UDG eldoLED, DUALdrive 0-10V, LOG UDN eldoLED, DUALdrive 0-10V, LIN UAD1/ Athena Control, UADR EldoLED, DUALdrive* UCD1/ Casambi Control, UCDR EldoLED, DUALdrive* *(Includes Node. Extended lead time, consult factory for EM use)	ROUGH-IN JBMP 4" Sq. or 4/0 Junction Box Mounting Plate FINISH OUT CMJB * 1/2" and 3/4" Conduit Ceiling Mount Junction Box* *(Available in powdercoat finishes. Alumina finish fixtures ship with Black powdercoat CMJB.) SMK3 3/0 Surface Mount Kit* SMK4 4/0 Surface Mount Kit* *(Dry/Damp rated)

PART NUMBER NOTES

- CY1X ships as e.g., CY1XAD1WHWH80S17A304041CE3
- Remote driver ships as e.g., PS-RMT-80S17A-1RE3
- Mounting part numbers listed on page 6



CYLINDER 1 SURFACE MOUNT

ACCESSORIES

ALTERNATE MEDIA

- SFL-CY1X-03** Soft Focus Lens
- HCL-CY1X-03** Honeycomb Louver *
- CGL-CY1X-03** Clear Glass Lens *
- FGL-CY1X-03** Frosted Glass Lens
- FSFL-CY1X-03** Frosted Soft Focus Lens
- FLSL-CY1X-03** Frosted Linear Spread Lens
- CGL-LSL-CY1X-03** Clear Glass Lens W/ Linear Spread Lens*
- SFL-HCL-CY1X-03** Soft Focus Lens W/ Honeycomb Louver*

STATIC WHITE REPLACEMENT OPTICS

- RO-50-15-S** 15° optic
- RO-50-20-S** 20° optic
- RO-50-25-S** 25° optic
- RO-50-40-S** 40° optic
- RO-50-60-S** 60° optic

WARM DIM REPLACEMENT OPTICS

- RO-50-20-W** 20° optic
- RO-50-25-W** 25° optic
- RO-50-40-W** 40° optic
- RO-50-60-W** 60° optic

TUNABLE WHITE REPLACEMENT OPTICS

- RO-50-15-T** 15° optic
- RO-50-20-T** 20° optic
- RO-50-25-T** 25° optic
- RO-50-40-T** 40° optic
- RO-50-60-T** 60° optic

EMERGENCY LIGHTING - REMOTE MOUNT ONLY

During disruption of main power, emergency battery inverter provides temporary 120V or 277V to fixture.

- EMB-S-25-120/277-LEDX** 25 watt max capacity, 120 or 277 VAC 60Hz
- EMB-S-100-120-LEDX** 100 watt max capacity, 120 VAC 60Hz, 0-10V dimmable
- EMB-S-100-277-LEDX** 100 watt max capacity, 277 VAC 60Hz, 0-10V dimmable
- EMB-S-250-120/277-LEDX** 250 watt max capacity, 120 or 277 VAC 60Hz

***SHUNT REQUIRED FOR USE WITH ATHENA AND CASAMBI CONTROLS, CONSULT FACTORY FOR DETAILS.**

POWDERCOAT FINISHES

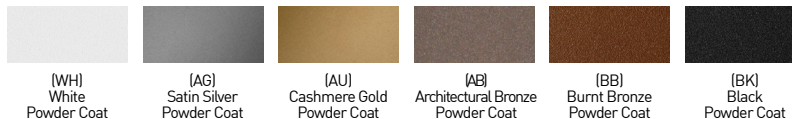

ALUMINA FINISHES BY LUCIFER LIGHTING™



CYLINDER 1 SURFACE MOUNT

STATIC WHITE PERFORMANCE - 3000K

LUMEN PACKAGE	WATTS	10° OPTIC NO LENS		15° OPTIC SOFT FOCUS LENS		20° OPTIC SOFT FOCUS LENS		25° OPTIC SOFT FOCUS LENS		40° OPTIC SOFT FOCUS LENS		60° OPTIC SOFT FOCUS LENS		WALLWASH WALLWASH LENS		ADJ. WALLWASH WALLWASH LENS	
		DLVD	LPW	DLVD	LPW	DLVD	LPW	DLVD	LPW	DLVD	LPW	DLVD	LPW	DLVD	LPW	DLVD	LPW
80S11A	11	-	-	891	76	1080	98	1088	98	1002	91	1104	100	1160	105	908	82
80S17A	17	1291	75	1451	73	1623	95	1624	95	1495	88	1643	96	1776	104	1357	79
90S11A	11	-	-	846	76	931	84	938	85	864	78	952	86	1000	90	783	71
90S17A	17	1113	65	1251	73	1399	82	1400	82	1291	75	1416	83	1531	90	1170	68
97S11A	11	-	-	744	67	819	74	825	75	760	69	838	76	880	80	689	62
97S17A	17	979	57	1101	64	1231	72	1232	72	1136	66	1246	73	1347	79	1030	60
90W18AL (2700K-1800K)	18	-	-	-	-	1049	61	1023	60	930	54	997	58	1082	63	844	46
90W18AD (3000K-1800K)	18	-	-	-	-	1039	61	1014	59	934	54	979	57	1122	66	875	48
90T17ATR (4000K-1800K)	17	-	-	1112	65	1230	72	1234	72	1157	68	1291	75	1192	70	994	58
90T17ATH (5000K-2700K)	17	-	-	1100	64	1213	71	1215	71	1174	69	1251	73	1178	69	982	57

OUTPUT MULTIPLIER

CCT	CCT SCALE
2400K	0.76
2700K	0.957
3000K	1.000
3500K	1.019
4000K	1.030

MEDIA LIGHT LOSS FACTOR

MEDIA	LIGHT LOSS FACTOR
No Lens	1.07
CGL	0.99
SFL	1.00
FGL	0.90
FSFL	0.84
FLSL	0.85
HCL	0.68
SFL+HCL	0.63



JA8-2022 INDICATED BY SHADING

UNIFIED GLARE RATING

10° OPTIC NO LENS	15° OPTIC SOFT FOCUS LENS	20° OPTIC SOFT FOCUS LENS	25° OPTIC SOFT FOCUS LENS	40° OPTIC SOFT FOCUS LENS	60° OPTIC SOFT FOCUS LENS	WALLWASH WALLWASH LENS
<16	<16	<10	<10	<10	<16	>19

TUNABLE WHITE MULTIPLIER

CCT	5000K-2700K	4000K-1800K
5000K	1.16	-
4000K	1.08	1.14
3500K	1.04	1.07
3000K	1.00	1.00
2700K	0.96	0.92
2400K	-	0.84
1800K	-	0.69

WARM DIM PERFORMANCE - SOFT FOCUS LENS - 60° OPTIC

INCANDESCENT DIMMING PROFILE

90W18AL 2700K - 1800K	Full on 100%	Dimmed to 80%	Dimmed to 70%	Dimmed to 50%	Dimmed to 20%	Dimmed to 10%	Dimmed to 2%
CCT (K)	2700	2650	2620	2520	2180	1950	1800
Light Output (Lm)	1216	973	851	608	243	122	24
Power (W)	18	14	13	9	4	2	0.4
Efficacy (LPW)	67	67	67	67	67	67	67

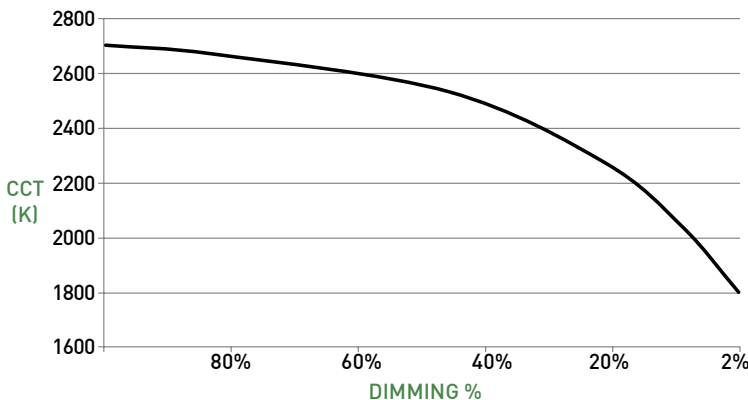

HALOGEN DIMMING PROFILE

90W18AD 3000K - 1800K	Full on 100%	Dimmed to 80%	Dimmed to 70%	Dimmed to 50%	Dimmed to 20%	Dimmed to 10%	Dimmed to 2%
CCT (K)	3000	2950	2920	2775	2375	2000	1800
Light Output (Lm)	1202	962	841	601	240	120	24
Power (W)	18	14	13	9	4	2	0.4
Efficacy (LPW)	66	66	66	66	66	66	66

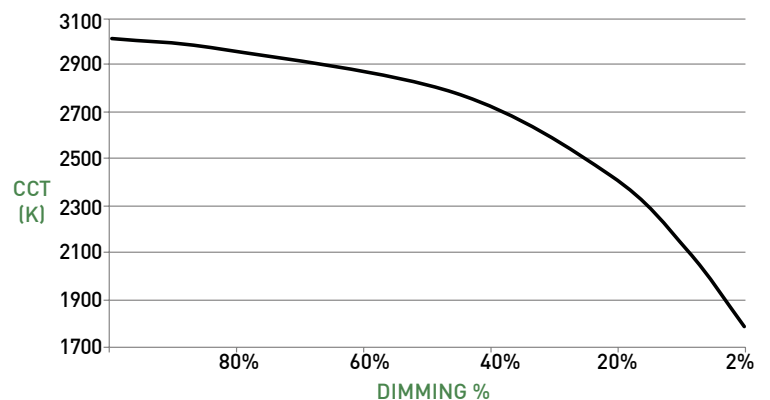

CYLINDER 1 SURFACE MOUNT

WALLWASH DESIGN GUIDE

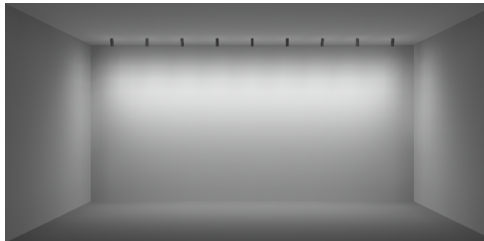

10° TILT

30" SETBACK / 30" ON CENTER SPACING

- 10FT CEILING SHOWN / 8-12FT IDEAL
- AVERAGE FC: 24.45
- MAX / MIN: 4.85
- 9 FIXTURES / 25FT WALL SHOWN

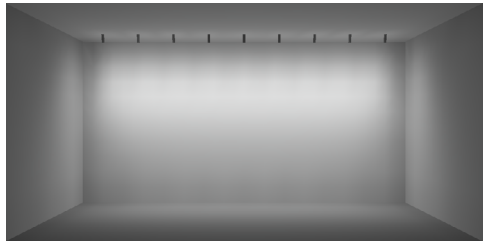

RECOMMENDED

15° TILT

36" SETBACK / 36" ON CENTER SPACING

- 10FT CEILING SHOWN / 8-12FT IDEAL
- AVERAGE FC: 21.75
- MAX / MIN: 4.35
- 9 FIXTURES / 30FT WALL SHOWN

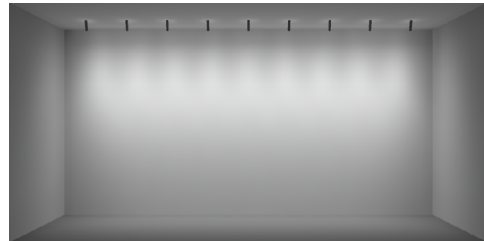

20° TILT

42" SETBACK / 42" ON CENTER SPACING

- 10FT CEILING SHOWN / 8-12FT IDEAL
- AVERAGE FC: 19.68
- MAX / MIN: 4.03
- 9 FIXTURES / 35FT WALL SHOWN

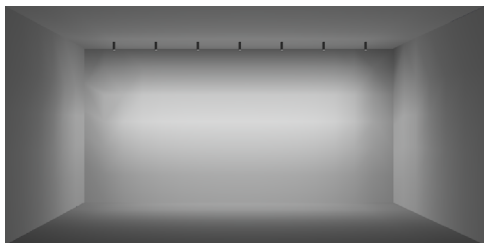

42" SETBACK / 30" ON CENTER SPACING

- 10FT CEILING SHOWN / 8-12FT IDEAL
- AVERAGE FC: 23.46
- MAX / MIN: 4.88
- 9 FIXTURES / 25FT WALL SHOWN

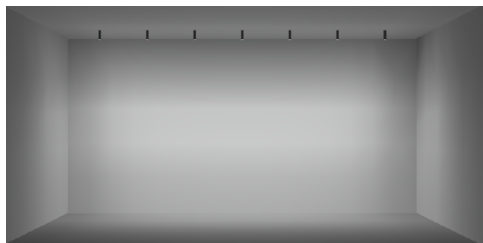

RECOMMENDED

48" SETBACK / 36" ON CENTER SPACING

- 10FT CEILING SHOWN / 8-12FT IDEAL
- AVERAGE FC: 18.62
- MAX / MIN: 4.76
- 9 FIXTURES / 30FT WALL SHOWN

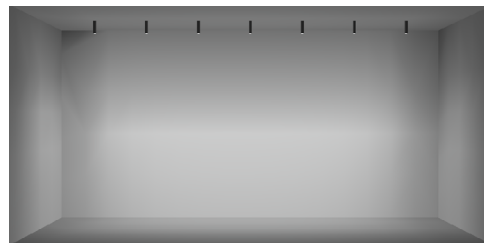

54" SETBACK / 42" ON CENTER SPACING

- 10FT CEILING SHOWN / 8-12FT IDEAL
- AVERAGE FC: 15.07
- MAX / MIN: 4.90
- 9 FIXTURES / 35FT WALL SHOWN

ADDITIONAL SETBACKS AND SPACINGS

ON CENTER SPACING	SETBACK / TILT			ON CENTER SPACING	SETBACK		
	30" / 10°	36" / 15°	42" / 20°		30"	36"	42"
30"	SHOWN ABOVE	AVERAGE FC: 25.42 MAX / MIN: 4.36	AVERAGE FC: 26.36 MAX / MIN: 4.14	42"	SHOWN ABOVE	AVERAGE FC: 20.84 MAX / MIN: 4.90	AVERAGE FC: 18.65 MAX / MIN: 5.04
36"	AVERAGE FC: 20.87 MAX / MIN: 4.97	SHOWN ABOVE	AVERAGE FC: 22.56 MAX / MIN: 4.08	48"	AVERAGE FC: 20.74 MAX / MIN: 4.66	SHOWN ABOVE	AVERAGE FC: 16.64 MAX / MIN: 5.04
42"	AVERAGE FC: 18.21 MAX / MIN: 5.17	AVERAGE FC: 18.94 MAX / MIN: 4.39	SHOWN ABOVE	54"	AVERAGE FC: 18.75 MAX / MIN: 4.75	AVERAGE FC: 16.82 MAX / MIN: 4.68	SHOWN ABOVE

***ALL DATA REFLECTS 90S17A WATTAGE PACKAGE**

CYLINDER 1 SURFACE MOUNT

CYLINDER ASSEMBLY

- A ADJUSTABLE - STANDARD CANOPY**
Die-cast canopy accommodates flat and sloped ceiling conditions. Conceals hidden mounting hardware. "AD" (90° tilt, 365° rotation) canopy features 1.76" (45mm) tall canopy. Available with integral or remote driver.
- B ADJUSTABLE - SHALLOW CANOPY**
Die-cast canopy accommodates flat and slope ceiling conditions. Conceals hidden mounting hardware. "AS" (90° tilt, 365° rotation) canopy features 0.65" (17mm) tall canopy, reducing overall height. Requires remote power supply.
- C FIXED BODY**
Body with integrated heat sink and LED. Conceals mounting hardware. Power supply may be integral or remote mount.
- D WALLWASH FIXED BODY**
- E OPTICS**
Robust light engine with optimized optic pairing integrates Reflection, Refraction, and TIR offering 10°, 15°, 20°, 25°, 40° & 60° beams.
- F MEDIA**
Cylinder accepts 2 lenses; soft focus lens, no lens, or wallwash lens standard. Sealed in place for Wet locations.
- G BAFFLE**
Die-cast baffle minimizes aperture glare and conceals view into fixture.
- H WALL-MOUNT**
Cylinder may be wall mounted using any mounting option.

DIMENSIONS / DRAWINGS

A ADJUSTABLE BODY STANDARD CANOPY

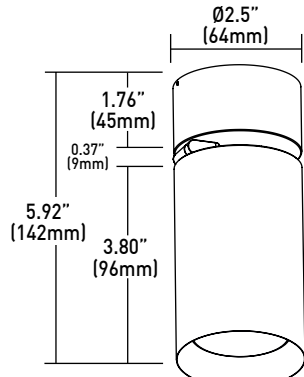

Cylinder weight
0.90 lbs

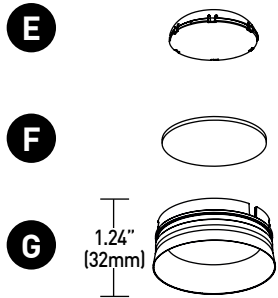

C FIXED BODY

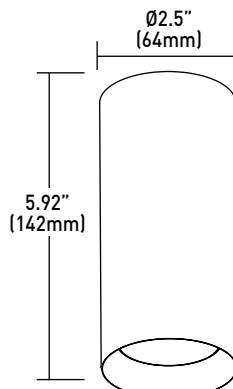

Cylinder weight
0.90 lbs

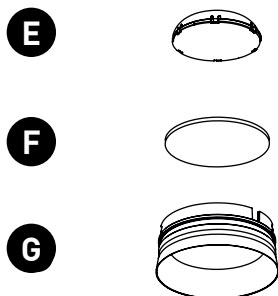

B ADJUSTABLE BODY SHALLOW CANOPY

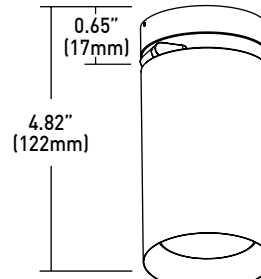

Cylinder weight
0.85 lbs

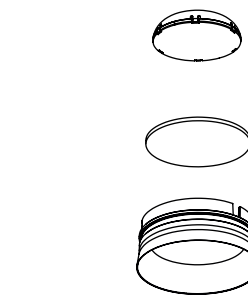

D WALLWASH FIXED BODY

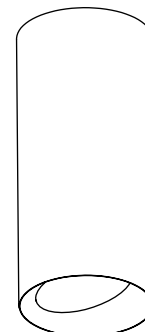

Cylinder weight
0.90 lbs

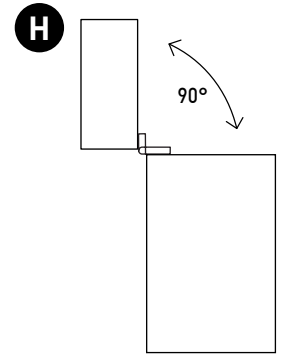
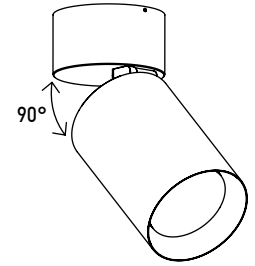

CYLINDER 1 SURFACE MOUNT

MOUNTING

- I JBMP**
Mounting plate (concealed) for standard 4" square or 4" 4/0 j-box. To be installed during rough-in prior to substrate. Fixture to mount flush with minimalist transition to ceiling.
Part Number - CY1X-JBMP
- J SMK3**
Surface mount kit includes mounting plate and 4" concealer plate that installs between fixture and standard 3" 3/0 j-box for existing applications where standard j-box cutout is to be concealed.
Part Number - CY1X-SMK-3/0-(FINISH)
- K SMK4**
Surface mount kit includes mounting plate and 5" concealer plate that installs between fixture and standard 4" 4/0 j-box for existing applications where standard j-box cutout is to be concealed.
Part Number - CY1X-SMK-4/0-(FINISH)
- L CMJB**
Ceiling mount junction box perfectly matches the cylinder profile for a continuous, integrated look where exposed ceiling mount junction box and conduit applications apply. For use with 1/2" and 3/4" EMT conduit only. Features two conduit entrances on either side and one conduit knockout on top of j-box. J-box is IP10 rated; painted finishes only. Blank off plugs included.
Part Number - CY1X-CMJB-(FINISH)

DIMENSIONS / DRAWINGS

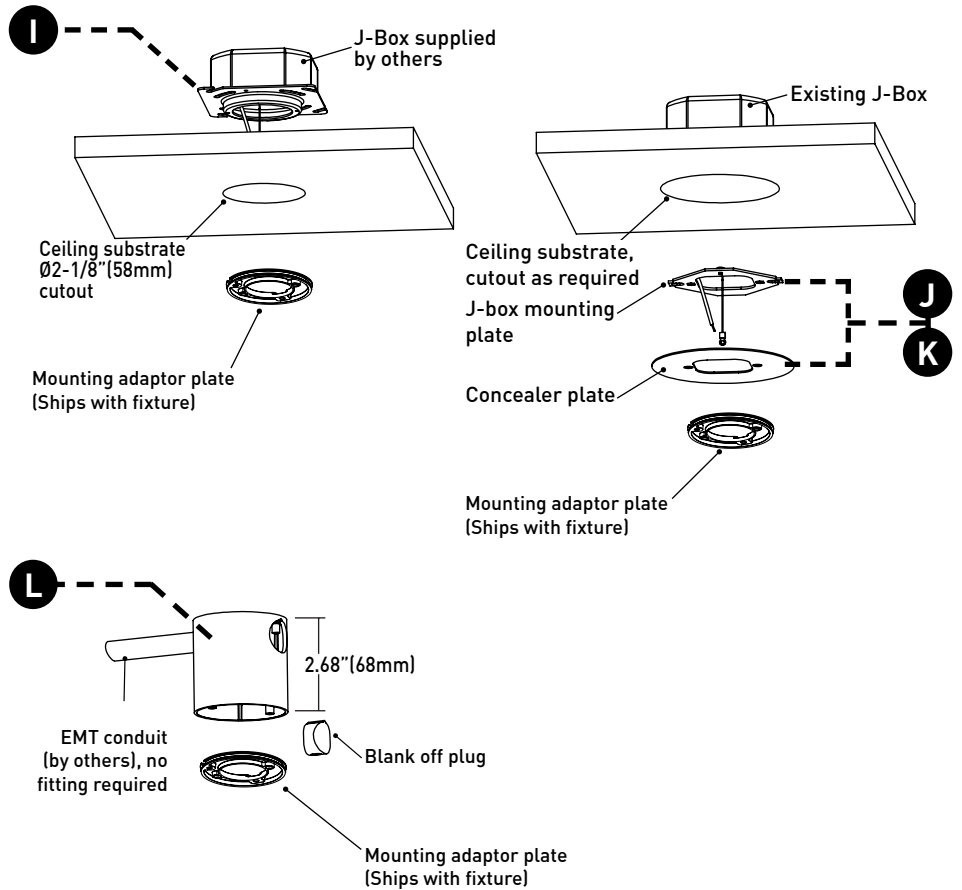

MOUNTING NOTES

- CY1X-JBMP and CY1X-SMK-3/0 & 4/0 not recommended for use with pancake style j-box.

REMOTE POWER SUPPLY

- M PS-RMT**
Remote power supply must be mounted in accessible area. Mounting device still required. Consult page 8 for dimming compatibility list. Consult install guide for complete details of suitable controls, wiring diagrams, and maximum allowable secondary run lengths between PS-RMT and cylinder.
- N ATHENA / CASAMBI CONTROL**
Controls integrated into remote driver assembly. All equipment is serviceable.
Athena Model Number: A-WN-D01-RF-BL & DC-OEM-DBI
Casambi Model Number: BT-S1E1-5400
- O ATHENA / CASAMBI EM SHUNT**
Included with drivers specified as ASR, ADR, CSR, or CDR. One required for each wireless EM fixture, requires class 2 control wiring between fixture and shunt. Features integrated test switch.
Model Number: PS-RMT-SHUNT

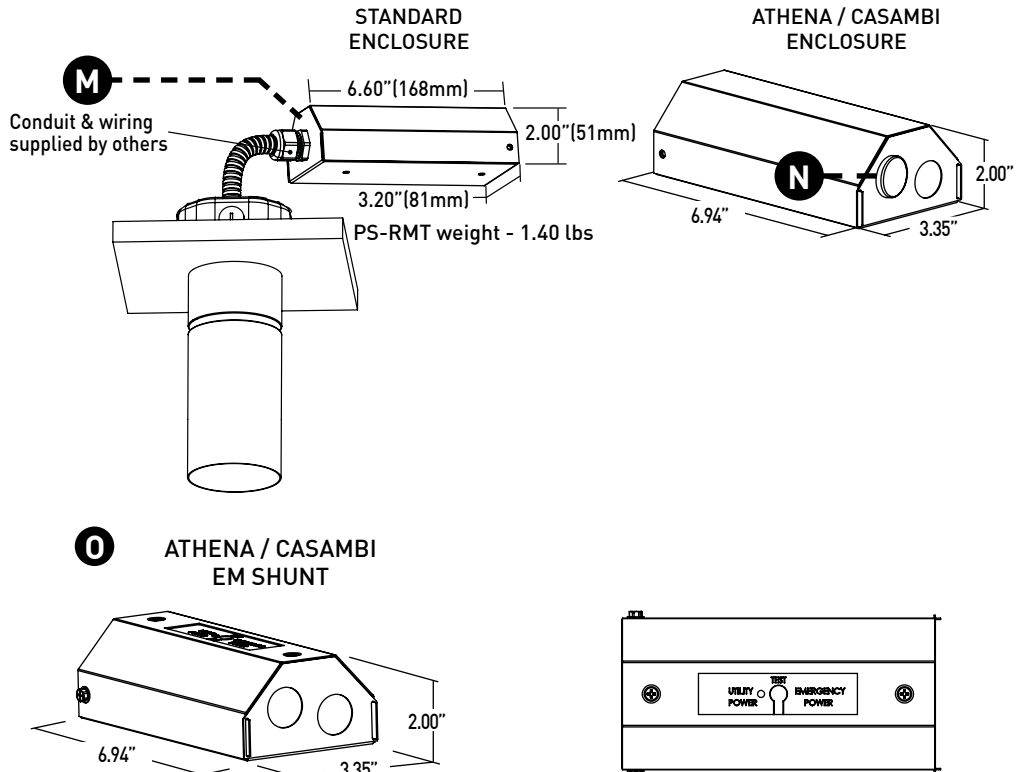

CYLINDER 1 SURFACE MOUNT

TECHNICAL

CONSTRUCTION

Cylinder: Die-cast aluminum body with integrated heat sink; painted finishes are granulated powder coat. Alumina finishes are anodized aluminum.

CMJB: Die-cast aluminum body; painted finishes are granulated powder coat.

Remote Power Supply: 22 Gauge galvanized steel.

STATIC WHITE LED

2-step MacAdam ellipse LED module available in 80+, 90+ and 95+ CRI configurations in color temperatures of 2700K, 3000K, 3500K and 4000K.

3-step MacAdam ellipse LED module available in 90+ CRI configuration in color temperature of 2400K. Average rated lamp life: 50,000 hours. LED and driver assemblies are field-replaceable.

WARM DIM LED

3-step MacAdam ellipse warm dim LED module available in 90+ CRI configuration. 3000K or 2700K at full brightness, warming to 1800K at full dim. Average rated lamp life of 50,000 hours. LED and driver assemblies are field-replaceable.

TUNABLE WHITE LED

3-Step MacAdam ellipse tunable white LED module available in 90+ CRI configuration. Features tuning range of 2700K to 5000K and 1800K to 4000K. Average rated lamp life of 50,000 hours. Driver assemblies are field-replaceable.

POWER SUPPLY PERFORMANCE AND DIMMING INFORMATION

Power Supply	PHASE			0-10V							ECO	DALI			ATHENA	CASAMBI
	1CE/1RE	1TR	1L2	UCA/URA	UAN	ULN	UEG	UEN	UDG	UDN	ULH	UED	ULD	UDD	UAS/UAD	UCS/UCD
Minimum °C	-20 °C	-20 °C	0 °C	-20 °C	-20 °C	-20 °C	-20 °C	-20 °C	-20 °C	-20 °C	0 °C	-20 °C	-20 °C	-20 °C	0 °C	-20 °C
Maximum °C	40 °C	40 °C	40 °C	40 °C	40 °C	40 °C	40 °C	40 °C	40 °C	40 °C	40 °C	40 °C	40 °C	40 °C	40 °C	40 °C
Dimming %	1.0%	2.0%	1.0%	1.0%	1.0%	1.0%	0.1%	0.1%	0.1%	0.1%	1.0%	0.1%	0.1%	0.1%	0.1%	0.1%

Note: For 1TR, 1L2, ULH, UAN, ULN, UEG and UEN drivers consult chart on page 7 to confirm appropriate dimming curve for compatibility with selected control.

MAXIMUM ALLOWABLE REMOTE DRIVER WIRING DISTANCES

DRIVER	WIRE AWG				
	12	14	16	18	20
URA, 1RE	-	164'	105'	66'	40'
1TR, UAN, ULN	285'	180'	113'	71'	45'
1L2, ULH	60'	40'	25'	15'	-
UEG, UEN, UED, ULD, DD1, DG1, DN1, UAS, UCS, UAD, UCD	-	-	118'	72'	46'

WALLWASH SPACING AND TILT

Adjustable Wallwash Cylinder must be tilted to achieve wallwashing effect. Recommended adjustable spacing is 36" (914mm) on center with 36" (914mm) setback from wall plane with 15° tilt. Recommended fixed spacing is 36" (914mm) on center spacing with 48" (1219mm) setback from wall plane.

MOUNTING

Cylinder is supplied with a mounting adaptor plate, which integrates with required additional mounting accessories specified separately according to field application conditions, providing a minimalist transition from standard 4/0 or 4" square junction boxes and accommodating ceiling thicknesses of 0.44" (12mm) to 0.75" (19mm). Ceiling-mount junction box available for 1/2" (13mm) and 3/4" (19mm) conduit and feature concealed internal clamps for clean fitting-free conduit exit and entry.

LISTING

cTUVus listed to UL1598 standard for Dry / Damp (IP30) and Wet (IP65) location. Title 24 JA8-2022 Listed. NEMA 410 Compliant. Buy American Act compliant.

DECLARE

LBC Red List Approved.

WARRANTY

Manufacturer's 1-year warranty guarantees product(s) listed to be free from defects in material and workmanship under normal use and service. 5-year warranty on LED and power supply to operate with 70% of the original flux and remain within a range of 3 duv. 10-year Lutron Advantage limited warranty available on Lutron equipped systems. Warranty period begins from the date of shipment by Seller. Consult [website](#) for full warranty terms and conditions.



CYLINDER 1 SURFACE MOUNT

DIMMING COMPATIBILITY

PHILIPS DRIVER COMPATIBILITY

Power supply 1TR Manufacturer	Family/Model #
Lutron Electronics	DV-600P
Lutron Electronics	DVELV-303P
Lutron Electronics	NTELV-600
Lutron Electronics	MAELV-600
Lutron Electronics	SELV-300P
Lutron Electronics	DVLV-600P
Lutron Electronics	NFTU-5A
Lutron Electronics	CTCL-153P
Lutron Electronics	GL-600H
Lutron Electronics	S-600P
Lutron Electronics	PHPM
Power supply UAN / ULN Manufacturer	Family/Model #
Lutron Electronics	DVTV plus PP-DV
Lutron Electronics	DVSCTV plus PP-DV
Lutron Electronics	DVSTV
Lutron Electronics	DVSCSTV
Lutron Electronics	QSGRJ-XP plus GRX-TVI
Lutron Electronics	QSGRJ-XE plus GRX-TVI
Lutron Electronics	QSGR-XE plus GRX-TVI
Lutron Electronics	NFTV plus PP-DV
Lutron Electronics	NTSTV
Lutron Electronics	RMJ-5T
Lutron Electronics	RMJS-8T
Lutron Electronics	FCJS-010
Leviton	IlumaTch IP7 series
Philips	Sunrise - SR1200ZTUNV

LUTRON DRIVER COMPATIBILITY

Power supply 1L2 Lutron Product Family	Part No.
Maestro WirelessR 600 W dimmer	MRF2-6ND-120-
Maestro WirelessR 1000 W dimmer	MRF2-10ND-120-
Caséta® Wireless Pro 1000 W dimmer	PD-10NXD-
GRAFIK T™ CL® dimmer	GT-250M-GTJ-250M-
HomeWorks® QS adaptive dimmer	HQRD-6NA-
HomeWorks® QS 600 W dimmer	HQRD-6ND-
HomeWorks® QS 1000 W dimmer	HQRD-10ND-
RadioRA® 2 adaptive dimmer	RRD-6NA-
RadioRA® 2 1000 W dimmer	RRD-10ND
myRoom™ DIN power module	MQSE-4A1-D
HomeWorks® QS DIN power module	LQSE-4A1-D
HomeWorks® QS wallbox power module	HQRJ-WPM-6D-120
HomeWorks® wallbox power module	HWI-WPM-6D-120
GRAFIK Eye® QS control unit	QSGR-, QSGRJ-
GRAFIK Eye® 3000 control unit	GRX-3100-GRX-3500-
RPM-4U module (LCP, HomeWorks® QS, GRAFIK Systems™, Quantum®)	HW-RPM-4U-120 LP-RPM-4U-120
RPM-4A module (LCP, HomeWorks® QS, GRAFIK Systems™, Quantum®)	HW-RPM-4A-120, LP-RPM-4A-120
GP dimming panels	Various
Ariadni CL 250W dimmer	AYCL-253P-
Diva CL 250W dimmer	DVCL-253P-DCSCCL-253P-
Nova T CL 250W dimmer	NTCL-250-
Power supply ULH Lutron Product Family	Part No.
PowPak Dimming Modules	RMJ-ECO32-DV-B
PowPak Dimming Modules	FCJ/FCJS-ECO
Energi Savr Nodes	QSN-1ECO-S
GRAFIK Eye QS control unit	QSN-2ECO-S
Homeworks QS control unit	QSGRJ- _E (wireless) QSGR- _E
Quantum Hub	QP2-__ 2C
Quantum Hub	QP2-__ 4C
Quantum Hub	QP2-__ 6C
Quantum Hub	QP2-__ 8C
Homeworks QS power module	LQSE-2ECO-D
myRoom Plus power module	

eldoLED DRIVER COMPATIBILITY

Power supply UEG / UEN Dimmer / Switch Control Manufacturer	Family/Model #
Busch-Jaeger	2112U-101
Jung	240-10
Leviton Lighting Controls	IP710-DLX
Lightolier Controls	ZP600FAM120
Lutron Electronics	Nova T® - NTFTV
Lutron Electronics	Dival® - DVTV
Lutron Electronics	Nova® - NFTV
Merten	5729
Pass & Seymour	CD4FB-W
The Watt Stopper	DCLV1
Sensor Switch	nIO EZ
Synergy	ISD BC
Power supply UEG / UEN Lighting Control Systems Manufacturer	Family/Model #
Lutron Electronics	GrafixEye® GRX-TVI w GRX3503
Lutron Electronics	Energy Savr Node™ - QSN-4T16-S
Lutron Electronics	TVM2 Module
Crestron®	GLX-DIMFLV8
Crestron®	GLXP-DIMFLV8
Crestron®	GLPAC-DIMFLV4-*
Crestron®	GLPAC-DIMFLV8-*
Crestron®	GLPP-DIMFLVEX-PM
Crestron®	GLPP-1DIMFLV2EX-PM
Crestron®	GLPP-1DIMFLV3EX-PM
Crestron®	DIN-A08
Crestron®	DIN-4DIMFLV4
Crestron®	CLS-EXP-DIMFLV
Crestron®	CLCI-1DIMFLV2EX
ABB	SD/S 2.16.1

ANALOG DRIVERS AND DIMMERS

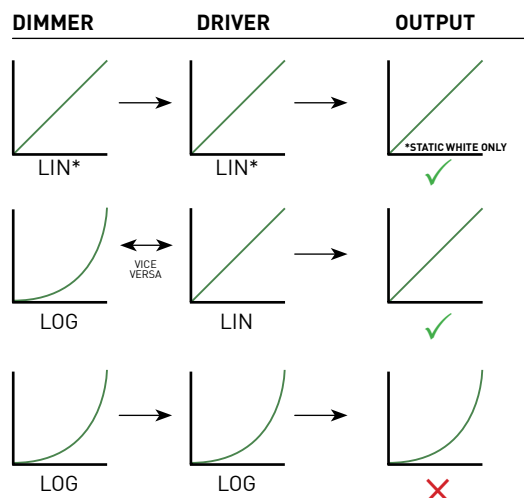

LIN = LINEAR
 LOG = LOGARITHMIC
 *LIN-TO-LIN NOT COMPATIBLE FOR WARM DIM

