

ATOMOS SLIM IC / NON-IC

RECESSED LED DOWNLIGHT HOUSINGS

INSTALLATION

Before beginning any DOWNLIGHT installation, disconnect electrical power at main switch or circuit breaker.

A. CAUTION

To reduce the risk of fire, electric shock, and potential damage to recessed housing assembly when electrical power is re-connected, DO NOT ATTEMPT TO CONNECT the following on branch circuit serving recessed downlight assembly:

- Motors
- Power tools
- Extension cords
- Appliances or similar electronics

Housings to be mounted in ceiling / plenum conditions *where ambient temperatures do not exceed 40°C.*

Lucifer Lighting LED housings must be used with Lucifer Lighting LED downlights.

Ensure AC input voltage is protected against surges & load shifts prior to power supply input.

B. SAFETY INSTRUCTIONS

1. Read installation instructions completely before attempting installation.
2. Failure to follow instructions may result in improper installation and void warranty.
3. Contact Lucifer Lighting Company with any questions or concerns before beginning any installation.
4. Ensure qualified electrician will perform all electrical procedures.
5. Disconnect electrical power circuit before attempting to install recessed downlight housing or trim, or if adding to or changing configuration of downlight housing or trim assembly.

6. Install / mount recessed downlight housing on structurally sound surface.
7. Recessed downlight housings may be installed in dry or damp locations only.
8. **IC / Non-IC Housing allows:** **Direct contact with** polycell spray-in foam insulation having max R-Value of 60 allowed on all sides and top of housing.
9. Do not attempt this installation if you do not understand these instructions.

C. HOUSING INSTALLATION

1. KEY FIXTURE COMPONENTS

Become familiar with wiring compartment and hanger bar assemblies.

Cover plate "Fig.1" provides access to wiring connections prior to installation of ceiling substrate and is retained with screws.

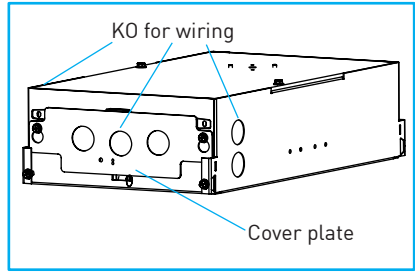

Fig.1

Driver assembly held in place with constant force spring "Fig.2". See Section H for instructions on servicing driver from below through housing aperture.

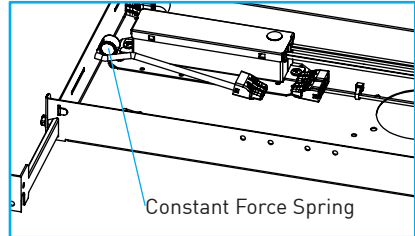

Fig.2

Remote Power Supply assembly features integral driver with separate primary and secondary wiring compartments "Fig.3".

Important: Remote driver must be mounted in accessible and serviceable area.

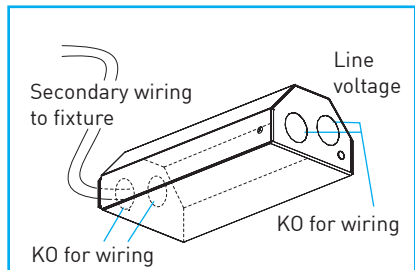

Fig.3

2. HANGER BAR ASSEMBLIES

Hanger bars extend from 14" to 24" on center and mount to short or long axis of housing "Fig.4". To install hanger bars on housing, slide mating halves together, joining through mounting bracket on housing sides. Secure position with locking screws "Fig.5". To mount hanger bars on long axis of housing, carefully bend the ends of the mounting brackets 90° towards the long axis of the housing before installing hanger bars "Fig.4".

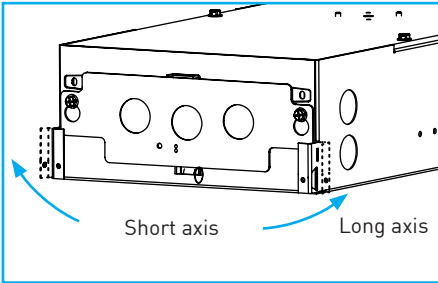

Fig.4

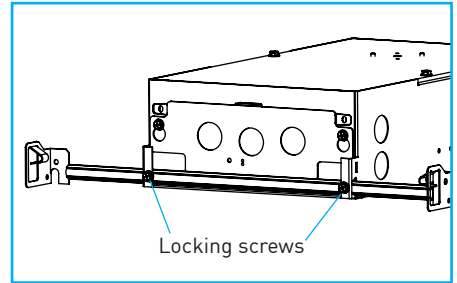

Fig.5

3. MOUNT HOUSING

Follow steps to ensure successful installation. For remodel installations, see Section H.

General Housing Mounting Notes:

Recessed downlight housings installed in accessible and non-accessible ceilings shall be supported from the structural members of the building.

Determine specified fixture location. With hanger bars properly affixed to housing (see Section C-2), secure hanger bars to selected framing member.

Wood or Metal Studs:

Position reference tab of hanger bar foot to underside of stud *"Fig.6"*. If wood stud, use integral nailing tab and suitable customer-supplied nails or screws to secure. If metal stud, use suitable customer-supplied screws *"Fig.7"*.

Note: Must use two nails or screws at each of four hanger bar feet.

T-Bar Frame:

Slide hanger bar over appropriately supported T-bar frame. Lock in place as required *"Fig.8"*.

Note: See Section E-6.6 for additional instructions regarding installation of ceiling tiles.

Furring Channel:

Bracket accommodates 1 1/2" depth furring channel as shipped. If using 7/8" depth furring channel, fold at break line and remove extension tab. Install bracket by latching it over the flanges of the channel. Fold tabs toward channel to lock bracket in place. Secure hanger bar to bracket using supplied screws *"Fig.9"*.

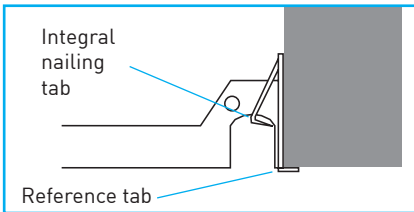

Fig.6

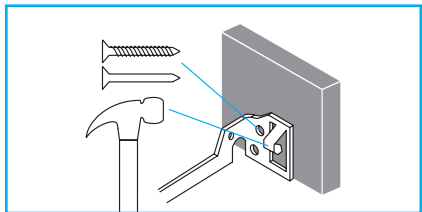

Fig.7

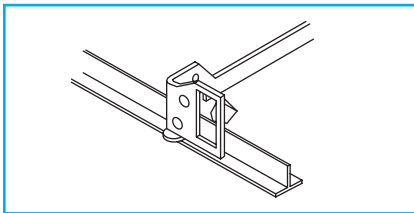

Fig.8

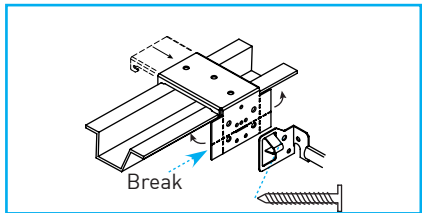

Fig.9

Verify correct housing aperture position using laser or string line, referencing housing aperture alignment marks. For square fixtures loosen collar locking screw and rotate collar as needed "Fig.10".

Tighten hanger bar locking screws to set lateral movement, and ensure all mounting screws are securely tightened (see Section C-2 and C-3).

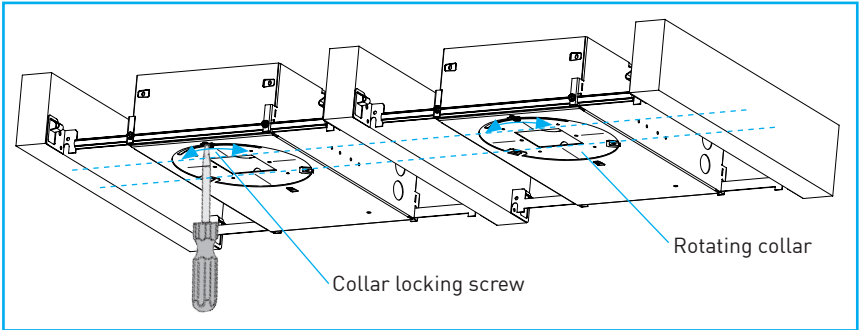

Fig.10

D. WIRING

1. HOUSING GENERAL WIRING NOTES

Note: Consult Safety Instructions in Section B prior to commencing wiring or servicing.

The housing assembly should be installed by a registered electrician and shall comply with National Electric Code (NEC) and local codes and ordinances .

The installer is responsible for furnishing proper electrical equipment and materials for the installation of the housings as intended by these installation instructions.

Install wiring in a manner to permit access to components and splice connections which may require future service. **14" (356mm) minimum customer-furnished feed wires** must be supplied within housing to accommodate future servicing.

Note: The Chicago Department of Buildings recommends 16" of lead be utilized for ease of servicing.

Metal conduit shall be used if required by applicable codes. Must use 90°C minimum supply wire only.

No part of the secondary circuit shall be grounded.

For systems that will be dimmed, consult controls manufacturer to verify control compatibility and for proper installation procedures and parameters.

2. WIRE HOUSING - UL 1598 INSTALLATIONS ONLY

WARNING: *Do not energize housing before removing disposable foam plug.*

To gain access to wiring compartment, loosen retaining screws and lift cover plate up and away "Fig.11".

Note: Removal of driver is **not** required.

Feed structured building wires through knockout, secure to corresponding connector "Fig.11" and tighten strain relief.

Quick connectors provided for line / mains voltage connection: black (hot), white (common) and green (ground) "Fig.12".

Note: Consult diagrams in Section I, wiring housing in accordance with the applicable driver type and proper selection of control voltage wires. Supplied internal wiring is 18-gauge with 300V-rated insulation.

Note: Ensure wires are firmly secured and not tangled prior to moving to the next step.

Push all wires into housing and reinstall cover plate, ensuring that no wires are pinched by cover.

Important: Confirm that housing is still in the preferred position.

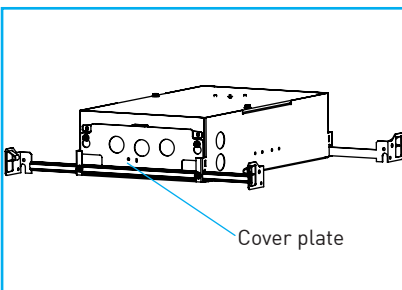

Fig.11

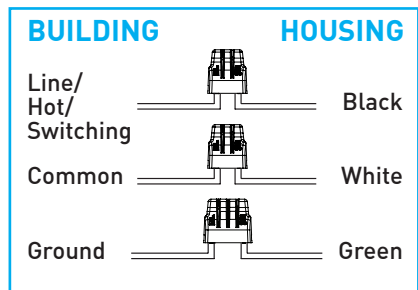

Fig.12

4. WIRE REMOTE POWER SUPPLY - UL 1598 INSTALLATIONS ONLY

WARNING: Do not energize housing before removing disposable foam plug.

Determine preferred mounting location, verifying fixture falls within maximum allowable wiring distance "Fig. 13".

Run adequately sized two-pair plenum rated wire between remote driver and housing or remodel fixture location, following installation guidelines for terminating as needed.

Note: Secondary wiring is polarized (+/-) and must be terminated correctly at both ends for proper operation. It is recommended to use Red (+) and Black (-) wires to avoid confusion. No part of the secondary circuit shall be grounded.

Ensure proper polarity is observed as reversed polarity may damage the unit and may void the warranty.

Access splice compartment by removing retaining screws, then tilting cover slightly back and away from base "Fig. 14".

Mount transformer back plate assembly to suitable substrate using customer-supplied screws "Fig. 15".

Insert line voltage wiring / conduit into line side of splice compartment and secondary voltage wiring / conduit into secondary side of splice compartment, utilizing appropriate strain relief or connector.

Note: Consult wiring diagrams in Section I for applicable driver type.

Join structured building wires to corresponding driver wires with suitable "customer-supplied" wire connecting device.

Push all wires and wire connections into splice compartment and reinstall splice compartment cover by aligning tab and slot, ensuring no wires are pinched by cover. Install retaining screws.

Lutron Drivers: "L2"

AWG Value	18	16	14	12
Distance (m)	4.5	7.5	12	18
Distance (ft)	15	25	40	60

Philips Drivers: "PH"

AWG Value	20	18	16	14	12
Distance (m)	14	22	34	55	87
Distance (ft)	45	71	113	180	285

eldoLED Drivers: "EG", "EN", "SG", "SN" & "ED"

AWG Value	20	19	18	17	16
Distance (m)	14	18	22	28	36
Distance (ft)	46	59	72	92	118

Fig.13

Min. 6" feed wires in splice compartment

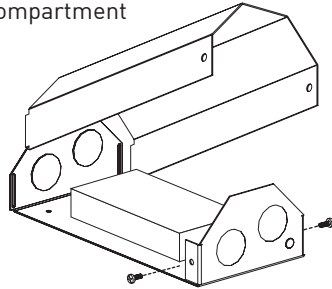

Fig.14

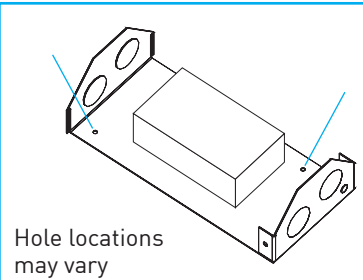

Fig.15

5. WIRE HOUSING - UL 2108 INSTALLATIONS ONLY

WARNING: Do not energize housing before removing disposable foam plug.

To gain access to wiring compartment, loosen retaining screws and lift cover plate up and away "Fig.16".

Note: Supplied internal wiring is 18-gauge with 300V-rated insulation.

Feed structured building wires through knockout, secure to corresponding connector "Fig.17" and tighten strain relief.

Quick connectors provided for low voltage connection: Red (+) and Black (-) "Fig.17".

Note: Ensure wires are firmly secured and not tangled prior to moving to the next step.

Push all wires into housing and reinstall cover plate, ensuring that no wires are pinched by cover.

Important: Confirm that housing is still in the preferred position.

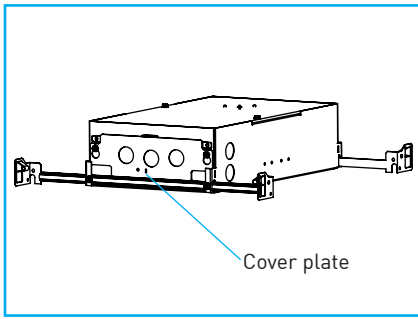

Fig.16

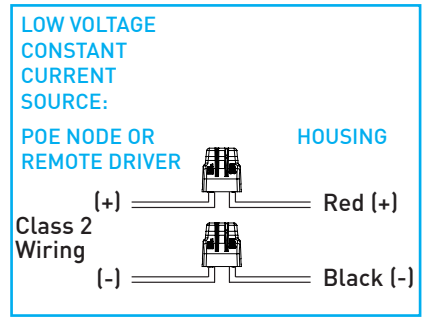





Fig.17

Drive Current Information:

	8012D	8016D	9010D	9014D	9009D	9013D
Minimum Vf	31.4	31.4	31.4	31.4	31.6	31.4
Maximum Vf	37.1	37.1	37.1	37.1	37.6	37.1
Current mA	280	350	280	350	280	350
Wattage W	10	12	10	12	10	12

Node Compatibility:

Manufacturer	Model Number
 Enabling Smart Buildings™	NP50-60-C-F-5
	180996-5107 180996-5101
	1 Channel Node, POE-LN2-1U-E 2 Channel Node, POE-LN2-2U-E 4 Channel Node, POE-LN2-4U-E

E. CEILING SUBSTRATE AND FINISH OUT

1. CEILING THICKNESS

Fixed downlight compatible with 0.50" (13mm) to 2.00" (51mm) ceilings.

Wallwash downlight compatible with 0.50" (13mm) to 0.625" (16mm) ceilings.

2. CEILING CUT-OUTS

Mark centerline of housing aperture, referencing measurements from adjacent walls and fixtures. Make clean cut-out with drywall cutting tool, using the inside diameter of housing aperture as a guide or consulting charts below for corresponding holesaw size "Fig.18".

HOUSING CUT-OUT

2-5/16" (59mm) for flange overlay

2-5/16" (59mm) for zero-sightline

3-1/2" x 3-1/2" (89mm) for trimless wood (Applies to drywall / backing only)

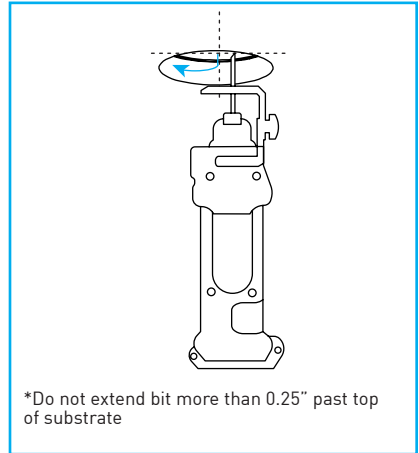

Fig.18

3. GYPSUM BOARD

Important: Square fixture installations require final alignment. Utilize string line or laser line to obtain uniform or desired alignment between multiple fixtures or in relation to parallel planes.

Install drywall in typical fashion. Oversized hole cut-outs must be filled in with mud or plaster, utilizing appropriate tape in accordance with industry standards, prior to trim installation.

Note: For mud-in drywall installations, see Section F.3.

Important: If mud-in, appliqué must be installed prior to mudding or finishing of ceiling. Failure to follow these instructions will lead to failed expectations and added expense.

Sand, prime, and apply finish coat to ceiling.

4. WOOD CEILING

Install wood in accordance with local and national building codes, employing suitable fire barriers as required. Hole cut-outs should be clean and precise. Sand, stain and apply finish seal coat prior to installing trim, on flange overlay applications, or baffle, on Trimless Wood applications.

Note: For trimless millwork installations, see Section F.4.

5. T-GRID LAY-IN TILE CEILING

Install tiles in accordance with manufacturer's recommendations.

Note: See General Housing Mounting Notes in Section C.3.

Important: Trimless / zero-sightline installations are not compatible with lay-in tile ceiling applications.

F. TRIM INSTALLATION

Ensure ceiling is finished before beginning trim installation.

1. FOAM PLUG

Remove foam cover from LED engine / slug and discard "Fig.19".

Note: Proceed to Section F.3 for MUD-IN installations or F.4 for MILLWORK installations.

2. FLANGED

Insert installation tool into trim "Fig.20" and secure feet to top of trim, directly above retention wheels as shown in "Fig.21".

Pull retention rollers up, using the installation tool as a guide, and raise trim assembly into housing aperture or ceiling cutout "Fig.22".

Release retention rollers and push the trim assembly up until flush with ceiling "Fig.23". Verify alignment if square.

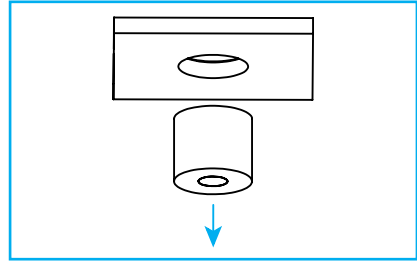

Fig.19

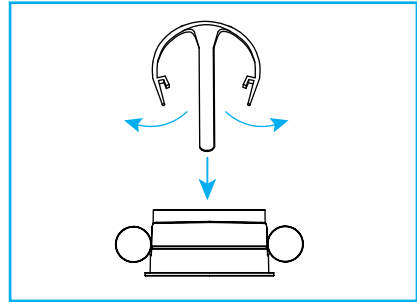

Fig.20

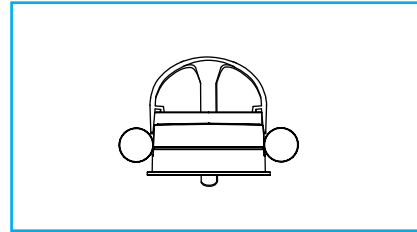

Fig.21

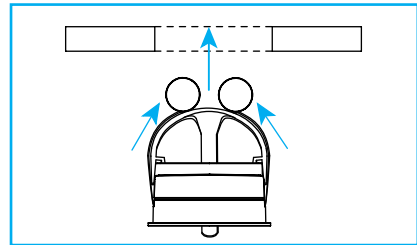

Fig.22

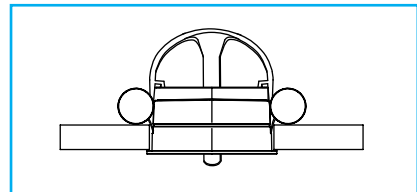

Fig.23

Gently push up on installation tool to disengage feet then remove by pulling down through aperture "Fig.24".

DO NOT DISCARD INSTALLATION TOOL

Installation tool is reusable for multiple fixtures.

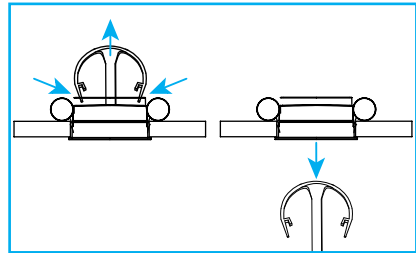

Fig.24

3. MUD-IN

Raise appliqué into the housing aperture or ceiling cutout and secure with screws provided "Fig.25". Verify alignment if square.

WARNING: Using screws longer than the ceiling substrate thickness can result in damage to the driver and wiring.

Install foam plug "Fig.25". Do not remove plug until all plaster and paint work is complete.

Use floating knife to apply first pass of drywall compound from beyond outer edge of appliqué to inner edge of appliqué / plaster stop. Float out as far as necessary to hide perforated appliqué and allow first pass of joint compound to dry "Fig.26".

Apply second coat of drywall compound level with screed edge, feathering compound as you move away from appliqué to give appearance of a perfectly flat ceiling "Fig.27". Allow drywall compound to dry and cure.

Gently use block sanding screen to sand surface "Fig.28" until desired level of smoothness is achieved.

WARNING: An unsatisfactory installation will occur if drywall compound is not sufficiently sanded and the flange / plaster stop is at all receded into the ceiling plane.

Once cured, the ceiling may be painted. After paint is dry, remove foam plug. Check for any drywall compound or paint that may have seeped beneath plug and carefully scrape if necessary.

Important: Any foreign material left in or on recessed appliqué surface may prevent proper baffle installation and satisfactory appearance.

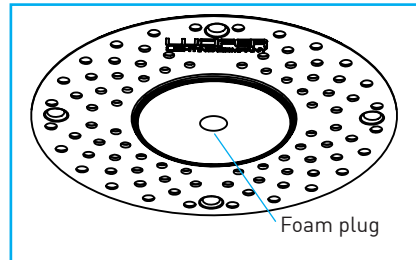

Fig.25

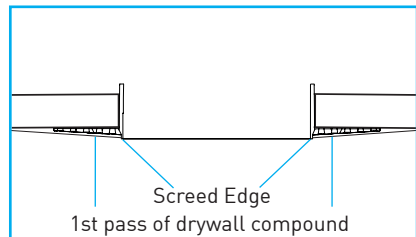

Fig.26

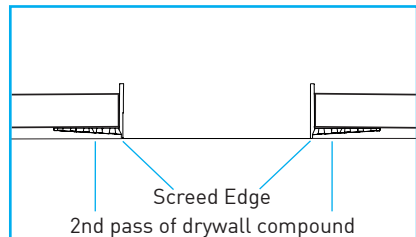

Fig.27

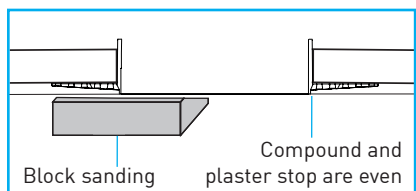

Fig.28

4. TRIMLESS WOOD

Determine the required spacer stack and counterbore depth based upon the finished wood layer thickness *"Fig.29"*.

Finished Layer	Counterbore (X)	Thin Spacer	Thick Spacer	Finish Spacer
1"	3/4"	1	4	1
7/8"	5/8"	1	3	1
3/4"	1/2"	1	2	1
5/8"	3/8"	1	1	1
1/2"	1/4"	1	0	1

Fig.29

Install spacers onto housing with supplied screws, positioning finish spacer furthest from housing, as shown in *"Fig.30"*. The combined thickness of the spacers and flange must be equal to the counterbore depth.

Using the installation tool outlined in Section *F.2*, pull the retention spring rollers up over the installation tool and raise the trim assembly into the aperture, release spring rollers and push the trim assembly up until flush with finish spacer *"Fig.31"*.

Remove installation tool.

DO NOT DISCARD INSTALLATION TOOL

Installation tool is reusable for multiple fixtures.

Install the disposable foam plug into the trim aperture to prevent contamination of the housing *"Fig.32"*.

WARNING: Failure to install disposable foam plug may result in fire.

WARNING: Do not energize housing before removing disposable foam plug.

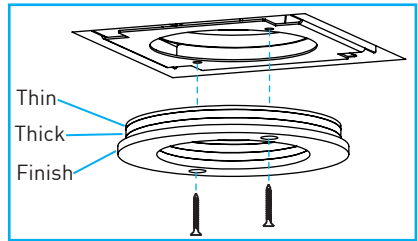

Fig.30

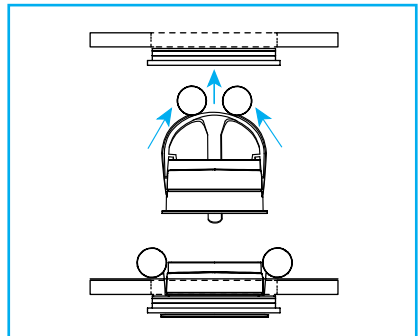

Fig.31

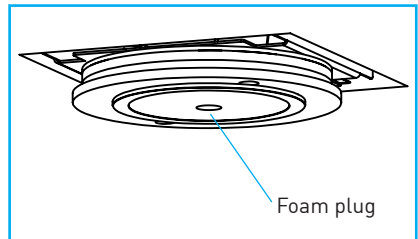

Fig.32

Note: Requires trim / compact router.

Locate and mark the centerline of the trim aperture on the finished wood layer. Drill a pilot hole to accommodate router bit (max 1.0" diameter) "Fig.33".

Important: Counterbore depth must be 1/4" less than the total thickness to ensure proper baffle fitment.

Counterbore a space larger than the trim using the predetermined depth in "Fig.29", ref "Fig.34".

Note: Factory does not recommend counterboring the entire width of wood.

Counterbore must be larger than the trim footprint to ensure finished wood layer can be installed "Fig.35".

Install finished substrate, ensuring the centerlines of the housing and substrate pilot hole are concentric "Fig.36".

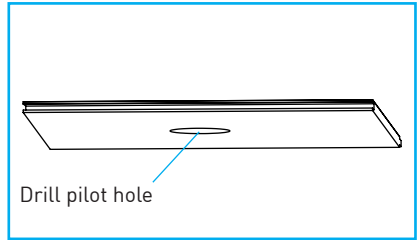

Fig.33

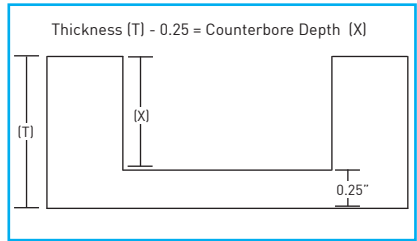

Fig.34

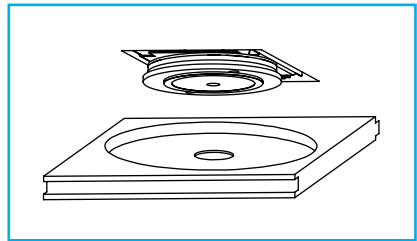

Fig.35

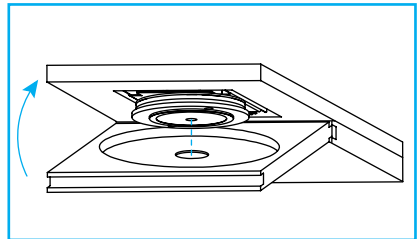

Fig.36

Utilizing a trim/compact router with a 1/2" diameter, 1" length, flush trim bottom bearing router bit, begin router cut in the pilot hole and move outward to inside diameter of trim edge. Continue and complete cutout using inside of trim as guide "Fig.37".

Note: Ensure tools used to square and clean cutout are sharp and clean.

On square installations, use a sharp utility knife to square the corners of the cutout to ensure proper baffle fitment "Fig.38".

As required, sand and apply stain and finish coat to ceiling.

Once all woodwork has been completed, clear debris using compressed air and remove foam plug "Fig.39".

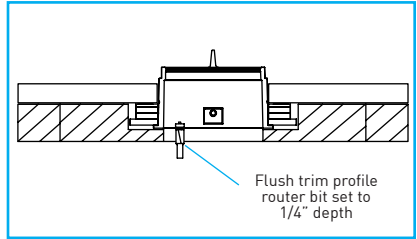

Fig.37

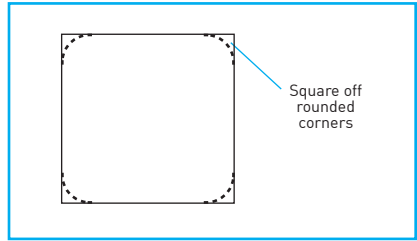

Fig.38

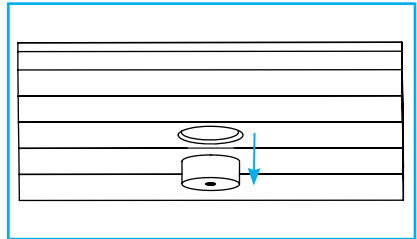

Fig.39

G. FIXTURE INSTALLATION

Note: Fixed LED engine ships pre-installed on fixtures.

1. INSTALL WALLWASH LED ENGINE AND OPTIC

Attach LED wiring to the corresponding 2-pin lever-nut connectors "Fig.40". Red to Red (+), Black to Black or Blue (-).

Warning: Connections are polarity sensitive.

Raise LED engine into the trim aperture and push-up until it seats on the slug tighten screws using provided x/x" Allen wrench "Fig.40".

Warning: Ensure the mounting surface is clean and free of dust and adequately tighten Wallwash LED engine screws, NOT doing so may result in failure of LED.

Ensure that both feet of optic properly engage LED base and twist clockwise to secure "Fig.41".

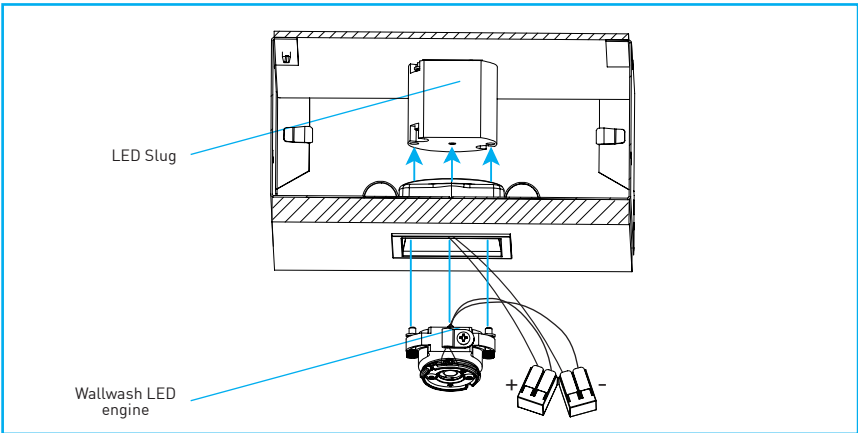

Fig.40

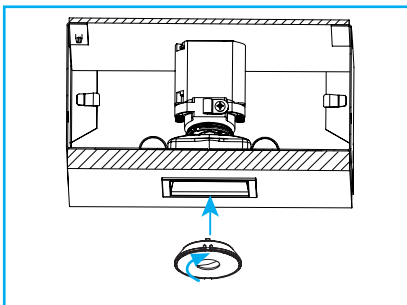

Fig.41

2. WALLWASH LED ALIGNMENT

LED module may be rotated up to 45° in each direction. To rotate LED module, remove optic and loosen the two lower 7/64" Allen screws highlighted in "Fig.42", rotate LED module and tighten screws "Fig.42".

LED module may also be removed and repositioned in 90° orientations. To reposition LED module, loosen the two upper 7/64" Allen screws highlighted in "Fig.43", reposition LED module and tighten screws "Fig.43".

Ensure LED is oriented towards the intended wallwash surface as shown in "Fig.44".

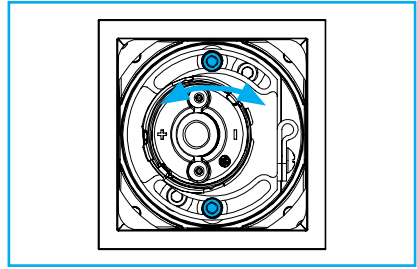

Fig.42

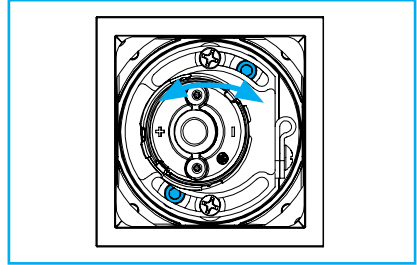

Fig.43

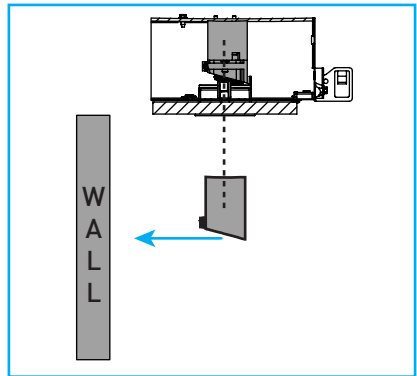

Fig.44

3. INSTALL Baffle

Push baffle up until just flush with the flange or the finished ceiling plane on trimless applications "Fig.45". Ensure wallwash baffle is oriented towards the intended wallwash surface as shown in "Fig.46".

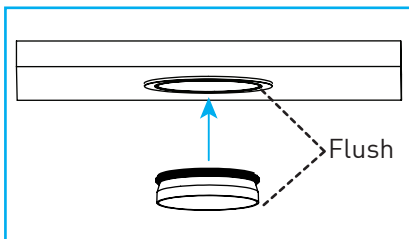

Fig.45

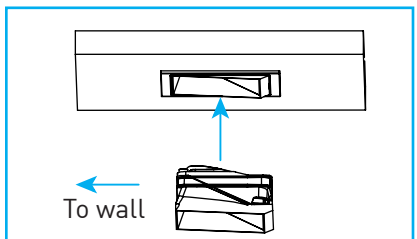

Fig.46

H. SERVICING FIXTURE

Important: Before servicing or maintaining trim or housing, disconnect electrical power at main switch or circuit breaker. Additionally, heed all WARNINGS and CAUTIONS, review the Safety Instructions, and refer to figures in main installation instructions where necessary.

1. EXCHANGING EFFECTS DEVICES

Note: Wet location and Pinhole baffle lenses are sealed in place. Consult factory for optional replacement baffle assemblies with alternate lens configurations.

A. Grasp baffle using soft gloves or with clean soft cloth and remove by pulling down.

B. To change lens, carefully push the lens up out of the baffle. Insert preferred lens in proper orientation, and carefully press it into place *"Fig.47"*.

C. To install honeycomb louver, raise up and clip onto optic *"Fig.48"*.

D. Push baffle up until just flush with the flange or the finished ceiling plane on trimless applications.

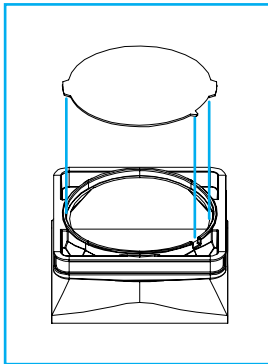

Fig.47

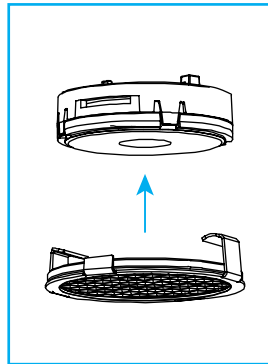

Fig.48

2. EXCHANGING OPTIC

A. Grasp baffle using soft gloves or with clean soft cloth and remove by pulling down.

B. To change optic, carefully grab and twist counter-clockwise to remove and clockwise to secure. Ensure that both feet of optic properly engage LED base.

C. Push baffle up until just flush with the flange or the finished ceiling plane on trimless applications.

3. LED ENGINE REPLACEMENT- SLIM HOUSING APPLICATIONS

A. Grasp baffle using soft gloves or with clean soft cloth and remove by pulling down.

B. Carefully grab the optic and remove it from LED base by twisting counter-clockwise.

Note: Make note of LED orientation before removing, replacing in same orientation.

C. Loosen the screws shown in “Fig.50” for fixed or “Fig.51” for wallwash using supplied 7/64” Allen wrench and lower LED engine through aperture.

D. Disconnect the LED engine wiring from the 2-pin lever-nut connectors.

E. Replace with new OEM LED engine assembly sourced through Lucifer Lighting. Attach LED wiring to the corresponding 2-pin lever-nut connectors, Red to Red (+), Black to Black or Blue (-).

F. Raise LED engine into the trim aperture and tighten screws using supplied 7/64” Allen wrench “Fig.52”.

G. Install optic to LED base by twisting clockwise to secure. Ensure that both feet of optic properly engage LED base.

H. Push baffle up until just flush with the flange or the finished ceiling plane on trimless applications.

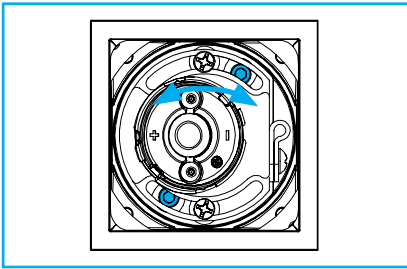

Fig.50

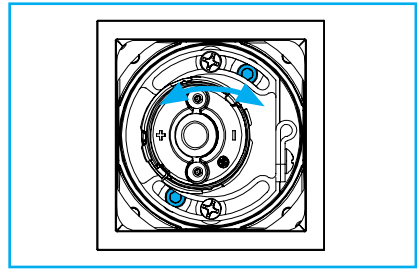

Fig.51

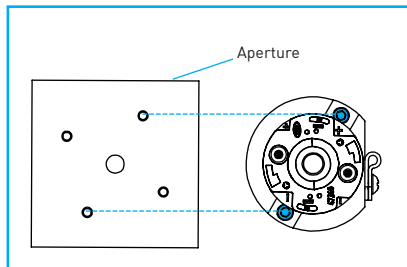

Fig.52

4. DRIVER REPLACEMENT - SLIM HOUSING APPLICATIONS

Caution: Take care to not damage or mar ceiling.

A. Grasp baffle using soft gloves or with clean soft cloth and remove by pulling down.

B. Carefully grab the optic and remove it from LED base by twisting counter-clockwise.

Note: Make note of LED orientation before removing, replacing in same orientation.

C. Loosen the screws shown in *"Fig.50"* for fixed or *"Fig.51"* for wallwash using supplied 7/64" Allen wrench and lower LED engine through aperture.

D. Disconnect the LED engine wiring from the 2-pin lever-nut connectors.

E. Driver sled is accessed through housing aperture. Pull on sleeved wires to release driver sled *"Fig.53"*.

F. Rotate driver sled assembly as required to facilitate guiding down, through and just below trim aperture *"Fig.53"*.

Important: Driver sled spring can detach from housing, if pulled too far out of aperture. Though only required for shipping, maintaining attachment simplifies reinstallation of driver sled.

G. Disconnect driver wiring from push-in connectors to free sled from housing.

F. Remove driver from sled and replace with OEM driver sourced through Lucifer Lighting *"Fig.54"* (Driver may differ from unit shown).

H. Connect driver wiring to 2-pin push-in connectors from housing.

I. Guide driver sled back through trim aperture and return to original position within housing *"Fig.54"* (Driver may differ from unit shown).

J. Attach LED wiring to the corresponding 2-pin lever-nut connectors, Red to Red (+), Black to Black or Blue (-).

K. Raise LED engine into the trim aperture and tighten screws using supplied 7/64" Allen wrench *"Fig.52"*.

L. Install optic to LED base by twisting clockwise to secure. Ensure that both feet of optic properly engage LED base.

M. Push baffle up until just flush with the flange or the finished ceiling plane on trimless applications.

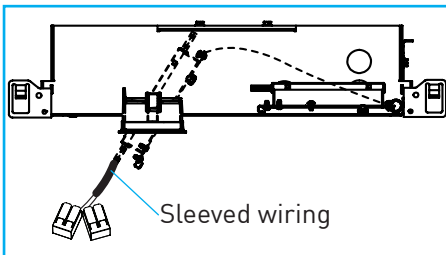

Fig.53

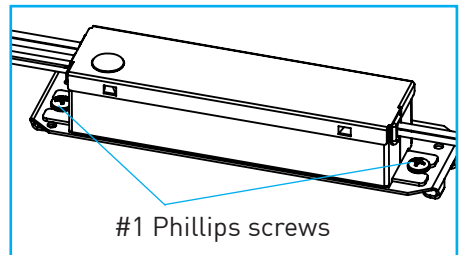

Fig.54

I. DRIVER WIRING DETAIL

GENERAL WIRING NOTES

1. Consult approved dimmer list to ensure compatibility.
2. Install in accordance with manufacturer’s dimmer installation guidelines.
3. Secondary and 0-10V connections are polarity sensitive.

WIRING DIAGRAM FOR LINE DIMMING

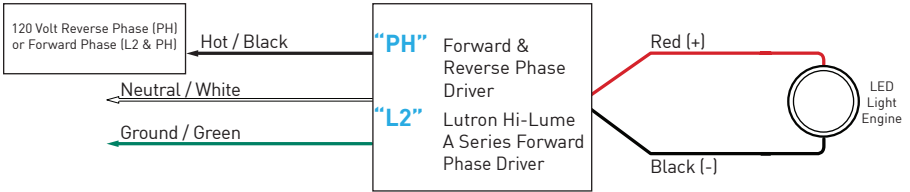

WIRING DIAGRAM FOR ANALOG CONTROL

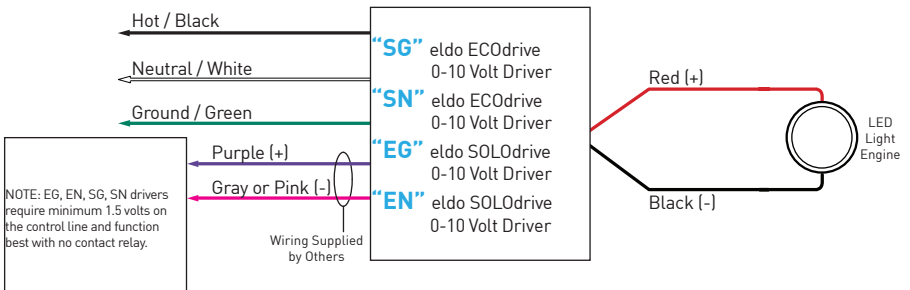

WIRING DIAGRAM FOR ECOSYSTEM AND DIGITAL CONTROL

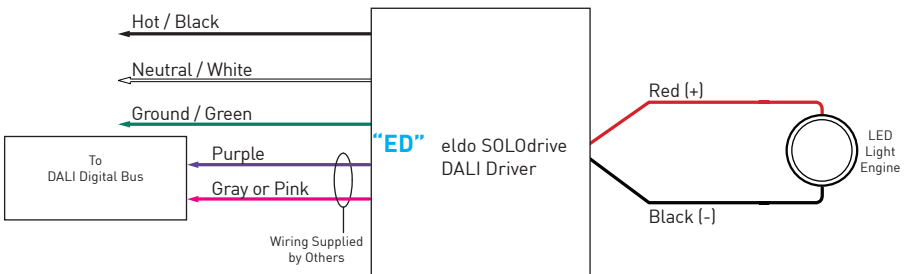

Please consult website for full warranty terms and conditions:
www.luciferlighting.com/warranty

[08012023]
3750 North PanAm Expressway
San Antonio, TX 78219 USA
[PH] +1 210 227 7329
[FAX] +1 210 227 4967
www.luciferlighting.com

LUCIFER®
LIGHTING COMPANY
©2023 Lucifer Lighting Company
As part of its policy of continuous research and product development, the Company reserves the right to change or withdraw specifications without prior notice.